

Cylinders

TESA

ASSA ABLOY



Global leaders in cylinder manufacturing



TESA cylinders are manufactured according to the most advanced production processes, offering an extremely secure high quality product and meeting the requirements the market demands in every different area.

TESA's range of cylinders includes a great variety of profiles in every system. TESA also offers the possibility of combining mechanical cylinders with access control systems.

Security

Ranging from the most basic to the highest security patented, restricted-key models, our cylinders have been equipped with the most advanced protection systems: spring loaded pins, antiremoval system, etc., as befits TESA's position as the first European cylinder manufacturer. Our restricted key systems guarantee that no blank keys will be found in the market, thus ensuring protection against counterfeit keys.



A wide range

We have classified our systems according to four standards:

- » Type of key (dimple or sawn)
- » Restricted key
- » Degree of security
- » Masterkeying capacity

The combination of such standards has created a peerless range in the market, covering every requisite in projects ranging from the residential to the institutional, from cost-efficient technical systems to high security patented systems, offering the distributor maximum profitability.



Masterkeying capacity

All TESA systems can be master keyed. A masterkeying is a planned locking system in which the master key can open more than one cylinder, even if each cylinder has its own key. For offices, residential homes and plants of various sizes, masterkeying is the immediate solution that allows to establish an access control while reducing the number of keys that must be handled: security and comfort.



Guaranteed by TESA

TESA meets the most demanding European standards for architectural fittings, in which cylinders are very important components in terms of protection and personal safety. Specifically, the EN 1303 European standard establishes five degrees of security (fire resistance, security against breakage, number of combinations, durability and corrosion resistance) for cylinders, based on design requisites and on practice tests simulating an attack.

The DIN standard specifies which standards must be met by cylinders in order to obtain masterkeying certifications. Other standards and certifications met by TESA's cylinders are UL (USA), NEN (Holland) and SS (Sweden).



TESA WIZARD. Express Service

Masterkey systems

- » Express manufacturing deadline 24h.
- » Express Delivery 24 additional hours.
- » Small surcharge for masterkeying.
- » A wide range of systems.

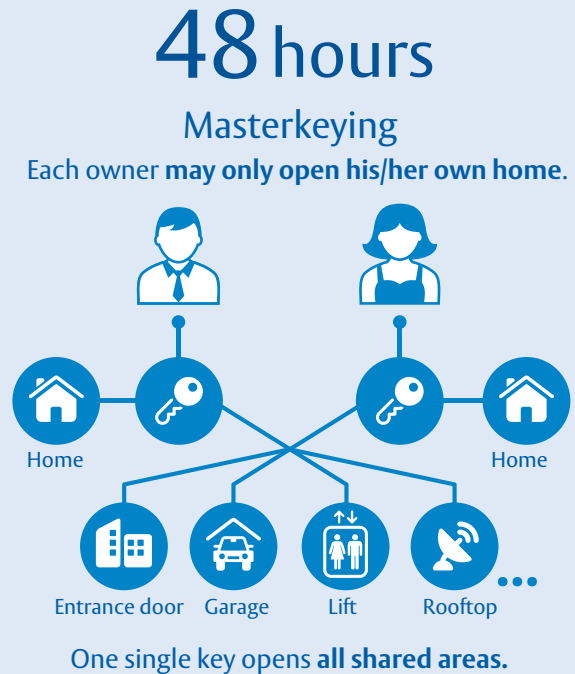

Key copies

- » Express manufacturing deadline 24h.
- » Low shipment fees. Express Delivery 24 additional hours.
- » A wide range of systems.
- » Monitoring of the key copie. Delivered in a sealed envelope with the requested amount of copies.



Now we will list the various subjects that we will tackle in this chapter:

- » **Terminology** employed when specifying the various parts that form a cylinder.
- » **Selection criteria.** Things that you should bear in mind when recommending any given system.
- » **Systems.** In this section we will define the features of each model.
- » **Profiles and models** for specific applications.
- » **Masterkey systems.** Where the most frequent diagrams are shown.
- » **Accessories** (blank keys, etc)

Introduction

Glossary

	Descripción
1	Barrel or body. The frame that supports the whole assembly
2	Plug/rotor. The main element that forms the cylinder's transmission. It sends the rotating motion from the key to the cam.
3	Cam. It operates the lock. It may come in various sizes depending on the manufacturing or design of the lock. In Spain, both types are used frequently 15 mm radius (for wooden doors) or 13,2 mm (for aluminium or PVC doors).
4	Clutch. The part that allows the user to monitor the side that sends the motion from the key to the cam. A version of the clutch exists that allows the user to open from the outside in case the key is inserted from the inside. This is called 'DS clutch' (DS = 'doble sentido', both directions).
5	Lower pin (main row). The part that determines the combination in a specific cylinder. It will condition the depth of puncturing that a correct key must have.
6	Upper pin (main row). It complements the lower pin and allows for the blocking of specific key combinations.
7	Spring. It loads the pin and makes it possible to bring it back
8	Key. The main accessory of the key. It allows the user to open the door.

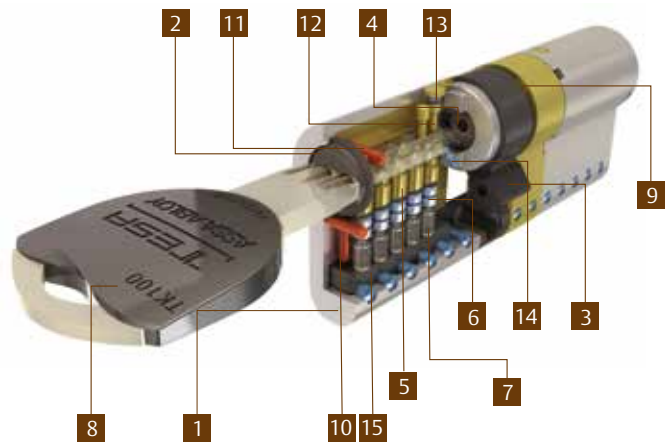

9	Clips. They secure the whole assembly.
10	Antidrill body pin. It provides security in case of antidrill tampering.
11	Antidrill rotor pin. It protects the rotor from the drill.
12	Lower pin (second row). Same function as the main row
13	Upper pin (second row). Same function as the main row.
14	Lower pin (third row). Radial distribution. It usually belongs to the system's patent.
15	Caps. They keep the pin loaded (lower and upper pin, spring).

Selection criteria

To select the most adequate model, TESA recommends taking into account the following points.

- » Key type. Either sawn or dimple.
- » Security level. Determines the performance of the cylinder against different opening methods.
- » Profile. Refers to the shape of the cylinder. Depends on the type of lockset.
- » Finish. There are two options. Either brass or nickel.
- » Measurement. It will depend on the door thickness.
- » Function. Specify the way of operating with the key. From both

- sides (double cylinder), only one side (single cylinder) or "one side key and thumb turn the other" (Cylinder & turn function).
- » Type of cam. It will be determined by the type lockset (for wooden doors, PVC doors...etc)
- » Format. Key to differ (there are no relationship between one cyl. and another), key alike (all the cylinders will be operated with the same key) and master keyed (where a hierarchy determines which keys can open particular doors).

Summary chart

	Key	Type	Security level	Master keying capability
TK100	Patented	Sawn key	**** ****	**** ****
TX80	Patented	Sawn key	*****	*****
TK6	Patented	Dimple key	*****	****
T80		Sawn key	***	***
T70	Patented	Sawn key	*****	
TD60	Patented	Sawn key	****	****
T60		Sawn key	**	*
TD5	Patented	Dimple key	**	***
TE5		Dimple key	*	**



Visual index

Standard range



TE5: Page 16

NEW



TD5: Page 21

Security range



T60: Page 25

NEW



TD60: Page 32

NEW



T70: Page 37



T80: Page 40

High security range



TK6: Page 46



TX80: Page 50



TK100: Page 57



Master key systems Page 54

Spare parts Page 58

Standard cylinders

TE5 system

Nickel-plated steel key.

Security

- » 5 spring-loaded pins.
- » 3 keys for each cylinder
- » Certified according to the EN1303 standard:2005

Masterkeying

- » 10 heights per position.
- » Only available for MKS extensions.

Security	Masterkeying
*	**



TD5 system

Patented nickel-plated brass key.

Security

- » 5 spring-loaded pins.
- » 3 patented keys for each cylinder
- » Certified according to the EN1303 standard:2005
- » Protected key copies available only presenting the propriety card.

Masterkeying

- » It features a MULTIPROFILE tree.

Security	Masterkeying
**	***

NEW



Security cylinders

T60 system

Nickel-plated brass key.

Security

- » 6 spring-loaded pins.
- » 5 keys per cylinder
- » Antibump system
- » Antidrill protection
- » Certified according to the EN1303:2005 standard

Masterkeying

- » Lateral pins available.
- » Only available for MKS extensions.

Security	Masterkeying
**	*



Security cylinders

TD60 system

Patented, non-duplicable key.

Security

- » 6 + 1 spring-loaded antipick pins.
- » Antidrill tempered steel pins in the barrel and the rotor.
- » Antibump system.
- » 3 patented, protected keys.
- » Certified according to the EN1303 standard
- » Protected key copies available only presenting the propriety card.

Masterkeying

- » Featuring a MULTIPROFILE system.

Security	Masterkeying
***	***

NEW



T70 system

Patented, non-duplicable key.

Security

- » 6 spring-loaded pins.
- » 5 non-duplicable, cylinder-patented keys.
- » Antibump and antidrill system, degree 2.
- » Double antisnap protection.
- » Antiextraction system DEGREE 2.
- » Narrow neck on the key.
- » Certified according to the EN1303:2005 standard
- » Protected key copies available only presenting the propriety card.

Masterkeying

- » Available in KD and KA, not in AM.

Security	Masterkeying
***	-

NEW



T80 system

Nickel silver key.

Security

- » 6 + 2 spring-loaded pins.
- » 5 keys per cylinder
- » Antibump system
- » Antidrill protection

Masterkeying

- » Lateral pins available.

Security	Masterkeying
***	***



High Security cylinders

ANTI-COPY SYSTEM
PATENTED

TK6 system

Patented, non-duplicable key.

Security

- » 6 + 1 spring-loaded antipick pins.
- » Antidrill tempered steel pins in the body and the rotor.
- » Antibump system.
- » 3 patented, protected keys.
- » Certified according to the EN1303 standard
- » Protected key copies available only presenting the propriety card.

Masterkeying

- » Lateral pins available.

Security *** **	Masterkeying ** **
-----------------------	--------------------------



TX80 system

Patented, non-duplicable key with SENSOR system.

Security

- » 6 + 2 + 1 spring-loaded antipick pins.
- » Antidrill hard metal pins in the body and the rotor.
- » Preinstalled double clutch.
- » Antibump system.
- » 5 patented, non-duplicable keys
- » Certified according to the EN1303:2005 standard
- » Protected key copies available only presenting the propriety card

Masterkeying

- » Various lateral pins and keyways available.

Security *** ***	Masterkeying *** **
------------------------	---------------------------



TK100 system

Patented, non-duplicable key with SENSOR system. Compatible with RFID technology (optional).

Security

- » 5 + 5 pins with multiple-tip tear-shaped section. (An exclusive TESA technology).
- » Anti-milling pins on rotor front.
- » Hard-metal antidrill pins in the body and the rotor.
- » Built-in escutcheon / antiextraction rotor
- » Advanced antibump.
- » The bridge has been reinforced with a steel bar. Maximum degree according to the applicable laws.
- » Double clutch as standard.
- » 5 patented, protected keys.
- » Certified according to the EN 1303:2005 standard
- » Cylinder compatible with narrow-inlet escutcheons.
- » Protected key copies available only presenting the propriety card.

Masterkeying

- » Maximum permutation capacity through the new (patented) orbital combination system.

Security **** ****	Masterkeying **** ****
--------------------------	------------------------------



D

Profiles

Euro double cyl.

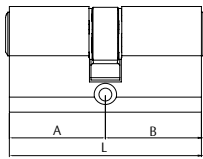

Euro single cylinder

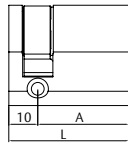

Knob cylinder

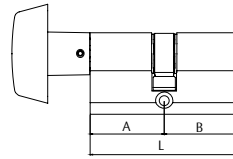

Adjustable european

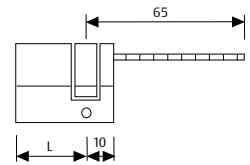

Round cylinder



Outside

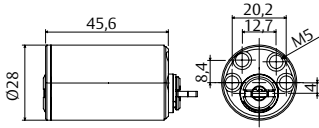

Inside

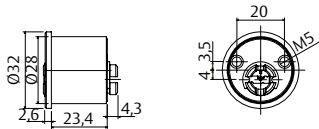

Multifort Round



Adjustable outside -
Replaceable inside

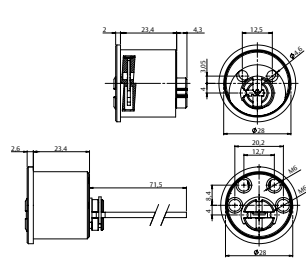

Adjustable round cyl.

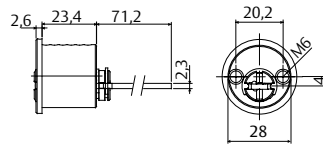

BRA

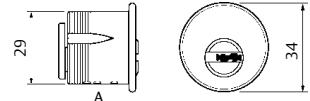

For knobsets (AM-KD-KA)

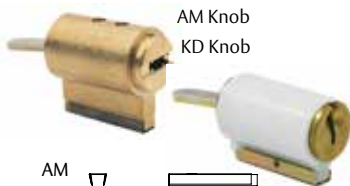

AM Knob
KD Knob

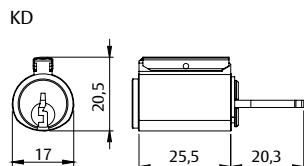
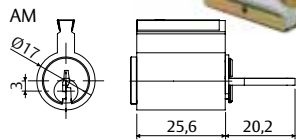

Padlocks



Interchangeable cylinder

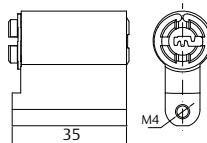

Profiles

682 Switching lock

Cylinders designed to commute an electric circuit using a key. There are three different models.

682 M23 model

Options

- » 2C. Includes 2 switches commuting two circuits simultaneously.
- » 1C. One only switch activates a circuit.
- » CR. Made with one switch and automatic return..
- » 2P. Lets to extract the key in two different positions. (Only available in Tx80 range)

Applications

- » Lift, garages and automatisms in general.

Max. Voltages: 0-15 VAC / 5A and 15-30 VAC / 3A

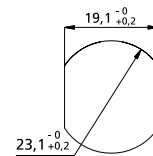

Required housing for installation.

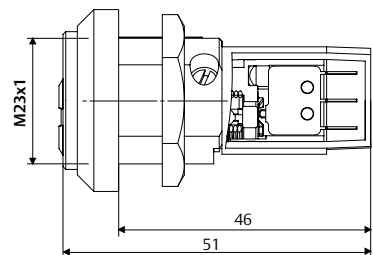
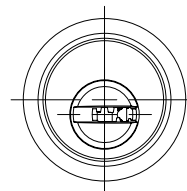

682 M27 model

Options

- » 2C. Includes 2 switches commuting two circuits simultaneously.
- » 1C. One only switch activates a circuit.
- » CR. Made with one switch and automatic return.

Applications

- » Lift, garages and automatisms.

Max. Voltages: 0-15 VAC / 5A and 15-30 VAC / 3A

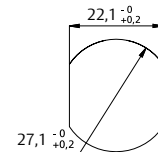

Required housing for installation.

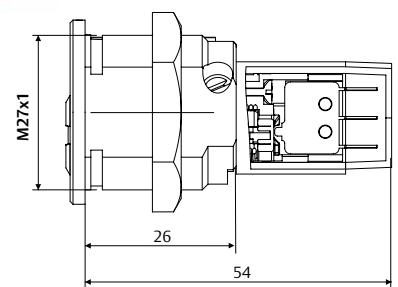
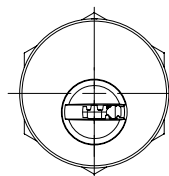

683 model

Options

- » 1C. One switch and a cam to activate an only circuit.
- » CR. Made with one switch and automatic return.

Applications

- » Lifts, garages and automatisms.

Max. Voltages: 0-15 VAC / 5A and 15-30 VAC / 3A

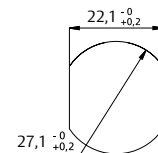

Required housing for installation.

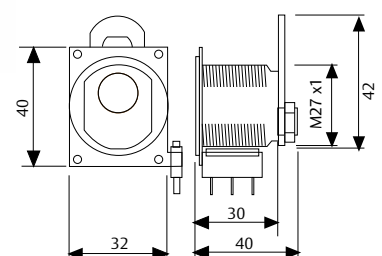

Profiles

682 cam locks

There are two versions available (M23 and M27) provided each with the lever shown on the technical drawing.

682 cam lock M23.

Options

» Different locking lever designs for different door thicknesses.

Applications

» Mail boxes, Box offices...etc.

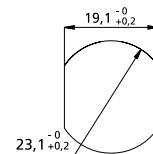

Required housing for installation.

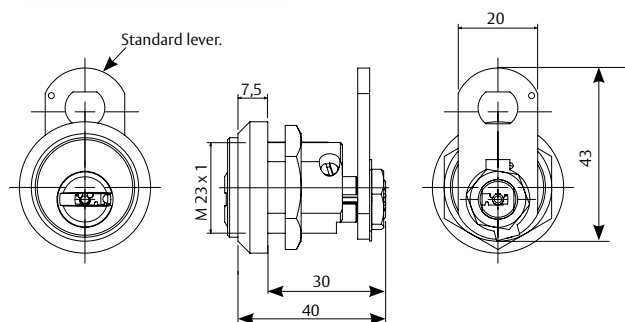

682 M27 cam-lock.

Options

» Different locking lever designs for a range of door thicknesses.

Applications

» Safes, box offices...etc.

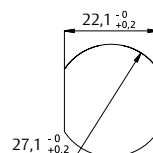

Required housing for installation.

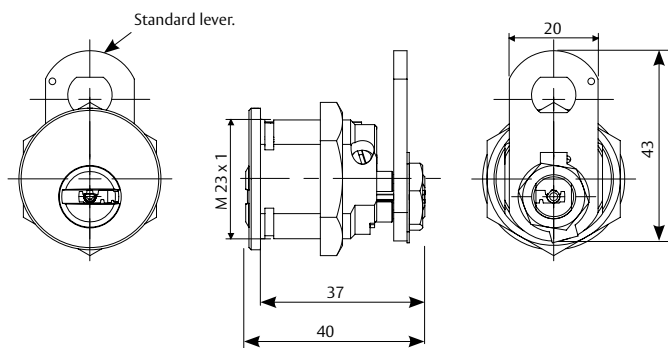

Profiles

682 Cam-lock

1. Opening type (possibilities)

This cam locks can be adapted very easily if you need to modify the standard turning. There is only to change the side where screw shown in the image is located.

The standard lever is 43mm long and flat and can be installed either vertical or horizontally. Thanks to the double window stamped at both sides.

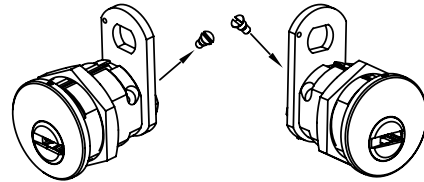

Turn to the right (Standard)

Turn to the left (Fixing screw changed) Vertical window.

Turn to the right. Horizontal window.

Turn to the left (Fixing screw changed) and horizontal window.

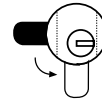
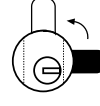
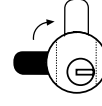
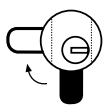
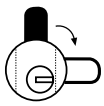

Lever black = locked / Lever white = Unlocked

2. Length and bent of the lever.

For those cases where a lever different to standard is needed we select the most appropriated from the list below.

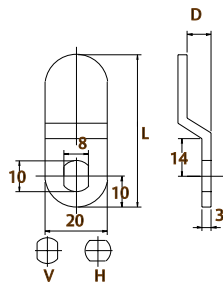
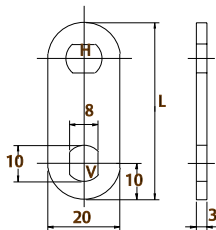

Length	Window	Product code
37	V + H	LEVA37VH
40	V + H	LEVA40VH
43	V + H	LEVA43VH
46	V+H	LEVA46VH

Length	Window	Product code
46	8	LEVA46VD8
46	8	LEVA46HD8
48	6	LEVA48VD6
48	6	LEVA48HD6

Minimum order qty. 5

3. Ring shields.

Useful when the length of cylinder is too much. There is one model for each shell dimension (M23 & M27)

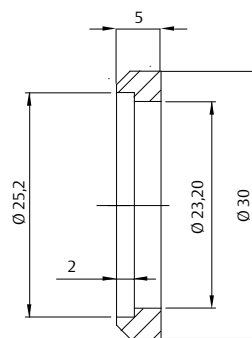

ESCUM23MN2
(For cylinders M23)

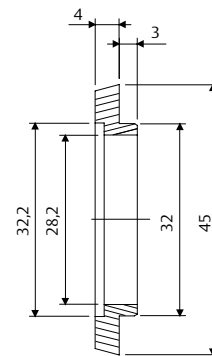

ESCEXTREG
(For cylinders M27)

4. Anti-turn plate.

Scope of delivery: 5 units.

Their mission is to avoid turning the cylinder while the user is operating with the key.

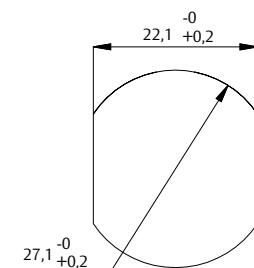
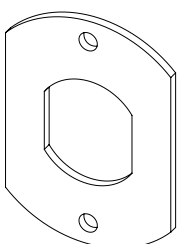

Anti-turn M27 technical
measures of the hole

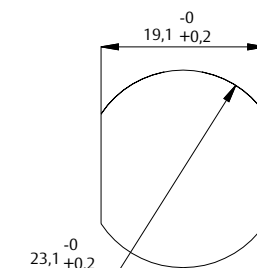

Anti-turn M23 technical
measures of the hole

Profiles

Modularity

New version in European profile thought to complete the range of measurements that are not available with the regular part numbers.

In addition to that, the modular version strengthens the core of the shell thanks to the union bar used which is made of steel.

To transfer an order using the corresponding part numbers (see the chapter T60, T80 and TX80) the specific dimension for side A-B will be required. The cam only if it is not R15 (DIN version).

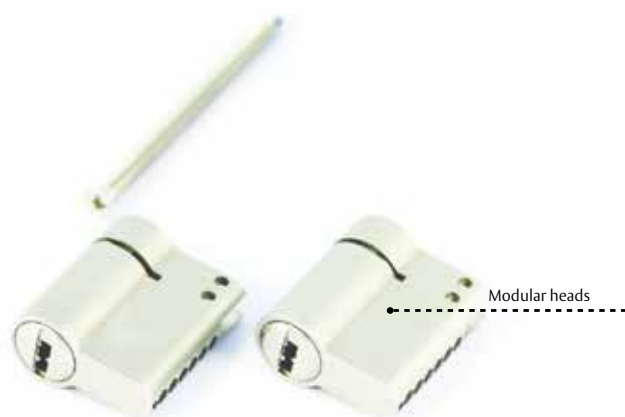

Components and modular heads

Solution developed to assemble unusual measurements in a quick and simple way.

Advantages:

- » Snap resistance. With these assemblies you will increase this level.
- » Express deliveries. Cylinders can be assembled in the hardware store.
- » To assemble every cylinder format (double, single, knob...) or measurement, TESA recommends both kits and the heads (available from T60).



Modular kit

Spare part kit

Other features available in cylinders

Service key cylinder

THE LIMITED ROTATION MOTION feature in the cylinder provides the cylinder with different rotation angles to the cam, depending on the key that will be inserted. Every cylinder is supplied with a service key and an ownership key.

SERVICE KEY: It can only activate a limited rotation angle in the cam. The result is that this key only allows the user to activate the latch, not the locking lever. The service key will not be able to lock the door with a lever, neither will it open the door once the lever has been pulled.

OWNER'S KEY: It will be possible to activate the 360° rotation cam, which will allow the user to activate the latch + lever in order to open or close the door.

This feature is available in the TX80. The references are of the **TX8.....LIM** type.

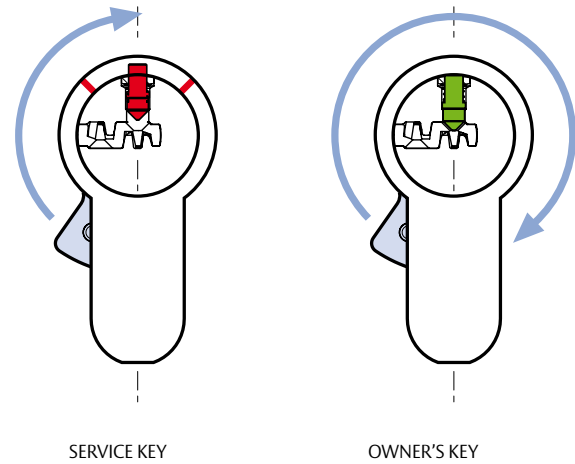

Anticorrosion and antisoiling

Anticorrosion

These cylinders provide components whose finishes increase considerably the cylinder's resistance in corrosion and salinity environments.

Antisoiling

These cylinders prevent dirt from entering the keyway (Dust-Cover Solution).

The ANTICORROSION and ANTISOILING features are available in the TX80. The references are of the **TX8G.....** type.



D

Standard cylinder TE5

Technical data

TE5 covers the basic segment of the range. Entirely manufactured and assembled in Spain is the most balanced solution for regular and master keyed installations.

Characteristics

- » Type: Sawn key. (Steel nickel plated).
- » Number of rows: 1
- » Number of pins: 5
- » Technology: Tumbler regular.
- » Permutation level: Grade 5.
- » Corrosion resistance: Grade B.
- » Pick protection: Medium level.
- » Lifespan: 50,000 test cycles.
- » 3 keys per cylinder.
- » Conform to EN-1303 regulation.

Options

- » Finishes: Brass / Nickel plated.
- » Cam: DIN R15 and R13
- » Formats available: key to differ, master keyed, key alike and specific codes.
- » Wide measurement and profile range.

Master key systems.

The platform which supports its manufacturing lets combine 10 heights per position. Thanks to that, the TE5 can face master key systems with total working guarantee. Capability graph (Average quantities)

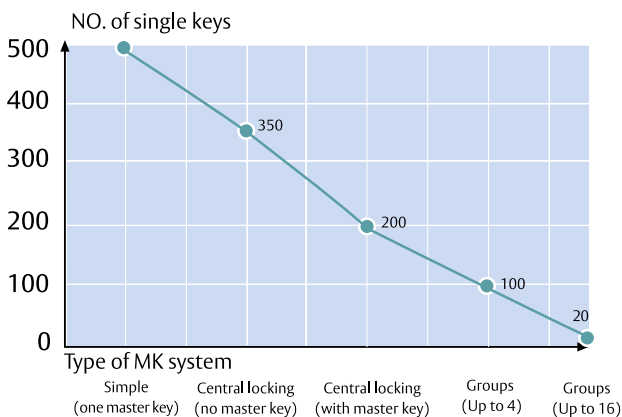

Security	Masterkeying
*	**



European standard regulation

In the same way as the main models included in the catalogue, TE5 is certified according to the European standard regulation.

	1	5	0	1	0	B	2	0
Key resistance (Grade 0-1)								
Lifespan (Grade 4-6)								
Door mass (Not applied in cylinder)								
Fire resistance (Grade 0-1)								
Safety of the people (Not applied in cylinders)								
Corrosion and temperature resistance (Grade 0-A-B-C)								
Key related security (Grade 1 to 6)								
Attack resistance (Grade 0 to 2)								

Recommendations

- » Use TESA lubricant to lengthen the maximum lifespan of the cylinder.
- » Use original keys to make copies.
- » For safety reasons, when you install a new cylinder, remember that once installed, it should not project more than 1mm.



Standard cylinder TE5

European profile



50 units (L≤90)
30 units (L>90)

Double european

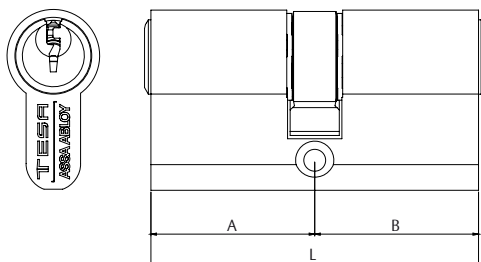

L	A	B	Cam = 15 mm	Finish	Cam = 15 mm	Finish
60	30	30	5030 30 30 L	Brass	5030 30 30 N	Nickel
65	30	35	5030 30 35 L	Brass	5030 30 35 N	Nickel
70	30	40	5030 30 40 L	Brass	5030 30 40 N	Nickel
70	35	35	5030 35 35 L	Brass	5030 35 35 N	Nickel
75	30	45	5030 30 45 L	Brass	5030 30 45 N	Nickel
75	35	40	5030 35 40 L	Brass	5030 35 40 N	Nickel
80	30	50	5030 30 50 L	Brass	5030 30 50 N	Nickel
80	35	45	5030 35 45 L	Brass	5030 35 45 N	Nickel
80	40	40	5030 40 40 L	Brass	5030 40 40 N	Nickel
85	35	50	5030 35 50 L	Brass	5030 35 50 N	Nickel
90	30	60	5030 30 60 L	Brass	5030 30 60 N	Nickel
90	35	55	5030 35 55 L	Brass	5030 35 55 N	Nickel
90	40	50	5030 40 50 L	Brass	5030 40 50 N	Nickel
90	45	45	5030 45 45 L	Brass	5030 45 45 N	Nickel
100	30	70	5030 30 70 L	Brass	5030 30 70 N	Nickel
100	40	60	5030 40 60 L	Brass	5030 40 60 N	Nickel
100	50	50	5030 50 50 L	Brass	5030 50 50 N	Nickel
110	30	80	5030 30 80 L	Brass	5030 30 80 N	Nickel
110	50	60	5030 50 60 L	Brass	5030 50 60 N	Nickel
120	30	90	5030 30 90 L	Brass	5030 30 90 N	Nickel
120	40	80	5030 40 80 L	Brass	5030 40 80 N	Nickel
120	60	60	5030 60 60 L	Brass	5030 60 60 N	Nickel
130	30	100	5030 31 00 L	Brass	5030 31 00 N	Nickel
140	40	100	5030 41 00 L	Brass	5030 41 00 N	Nickel
150	50	100	5030 51 00 L	Brass	5030 51 00 N	Nickel
160	60	100	5030 61 00 L	Brass	5030 61 00 N	Nickel

Single european

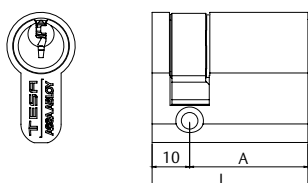

L	A	B	Cam = 15 mm	Finish	Cam = 15 mm	Finish
40	30	10	5030 30 10 L	Brass	5030 30 10 N	Nickel
45	35	10	5030 35 10 L	Brass	5030 35 10 N	Nickel
50	40	10	5030 40 10 L	Brass	5030 40 10 N	Nickel
60	50	10	5030 50 10 L	Brass	5030 50 10 N	Nickel
70	60	10	5030 60 10 L	Brass	5030 60 10 N	Nickel
80	70	10	5030 70 10 L	Brass	5030 70 10 N	Nickel
90	80	10	5030 80 10 L	Brass	5030 80 10 N	Nickel
100	90	10	5030 90 10 L	Brass	5030 90 10 N	Nickel

Knob european

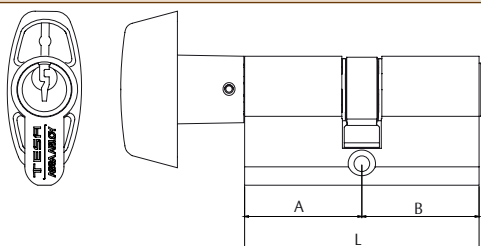

L	A	B	Cam = 15 mm	Finish	Cam = 15 mm	Finish
60	30	30	503B 30 30 L	Brass	503B 30 30 N	Nickel
65	30	35	503B 30 35 L	Brass	503B 30 35 N	Nickel
70	35	35	503B 35 35 L	Brass	503B 35 35 N	Nickel
70	40	30	503B 40 30 L	Brass	503B 40 30 N	Nickel
80	30	50	503B 30 50 L	Brass	503B 30 50 N	Nickel
80	40	40	503B 40 40 L	Brass	503B 40 40 N	Nickel
85	35	50	503B 35 50 L	Brass	503B 35 50 N	Nickel
90	30	60	503B 30 60 L	Brass	503B 30 60 N	Nickel
90	45	45	503B 45 45 L	Brass	503B 45 45 N	Nickel

* If you wish to order copies of the same key or masterkeying, just add KA or AM at the end of each reference. In the case of Masterkey systems, TE5 is Only available for MKS extensions.

* In order to choose the finish, select 'L' for brass or 'N' for nickel.

* The brass-plated finish in R13 is only available in sizes up to 80mm.

D

Standard cylinder TE5

European profile

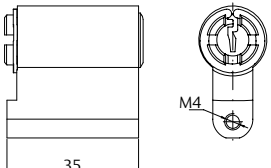
Padlock exchangeable	L	A	B	Product code	Finish
	-	-	-	T53CL55L	Brass
	-	-	-	T53CL55N	Nickel

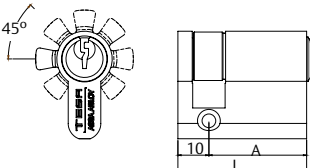
Adjustable cam. Single profile (8 positions)	L	A	B	Product code	Finish
	40	30	10	T53W3010L	Brass
	40	30	10	T53W3010N	Nickel

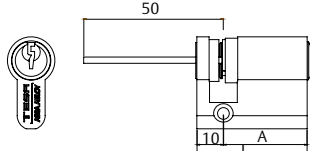
Adjustable european cylinder	L	A	B	Product code	Finish
	40	30	10	TE5R3010L	Brass
	40	30	10	TE5R3010N	Nickel
	50	40	10	TE5R4010L	Brass
	50	40	10	TE5R4010N	Nickel

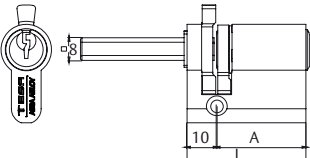
Euro cylinder for lock set 3,520.	L	A	B	Product code	Finish
	40	30	10	552000LT	Brass
	40	30	10	552000LN	Nickel

* If you wish to order copies of the same key or masterkeying, just add KA or AM at the end of each reference.

* In the case of masterkeyings, only available for MKS extensions.

Oval profile

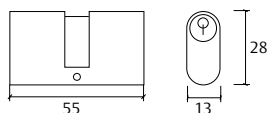
Oval profile for lock set 2,220*	L	A	B	Product code	Finish
	54	27	27	522060LN	Nickel
	54	27	27	522060LT	Brass

* It is not TE5. (MKS / KA not available)

* If you wish to order copies of the same key or masterkeying, just add KA or AM at the end of each reference.

* In the case of masterkeyings, only available for MKS extensions.

Standard cylinder TE5

Round profiles

Model 5000		Ø	Inside length	Outside length	Product code	Finish
		28	26 mm	26 mm	500000LT	Brass
Adjustable round cylinder		Ø	Inside length	Outside length	Product code	Finish
		27	-	Adjustable	55TE00LT	Brass
		27	-	Adjustable	55TE00LN	Nickel
Round for AUMON locks		Ø	Inside length	Outside length	Product code	Finish
		26	-	Adjustable	T53REGAUHL	Brass
		26	-	Adjustable	T53REGAUHN	Nickel
Accessories	Lenght			Product code	Finish	
TUBE	22			TUB2526L22L	Brass	
TUBE	22			TUB2526L22N	Nickel	

* Tubes to extend the length of the cylinder are sold apart

* If you wish to order copies of the same key or masterkeying, just add KA or AM at the end of each reference.

* In the case of masterkeyings, only available for MKS extensions.

D

Standard cylinder TE5

Round profiles

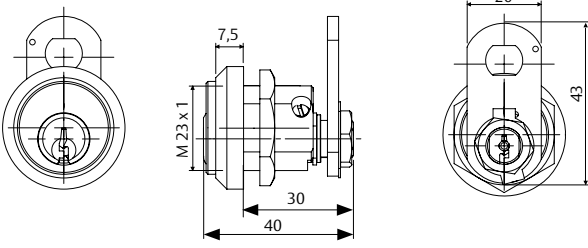
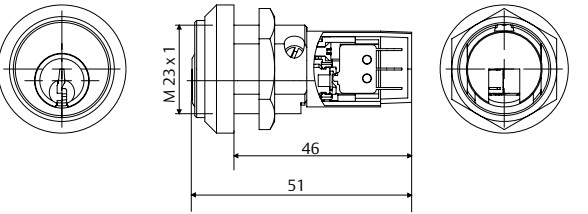
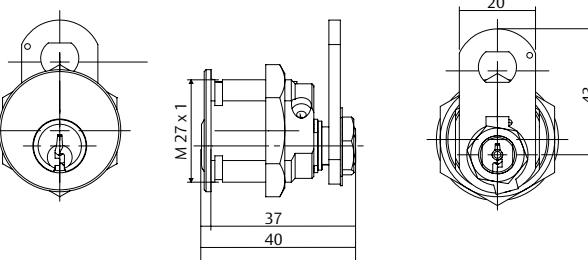
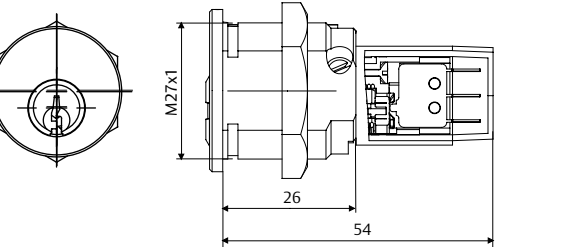
682			Metric	Type	Function	Product code	Finish
	23	Mechanic	-	682M23T5NM	Nickel		
	23	Electric	1 switch & return	682M23T5CR	Nickel		
	27	Mechanic	-	682M27T5NM	Nickel		
	27	Electric	1 switch	682M27T51C	Nickel		
	27	Electric	1 switch & return	682M27T5CR	Nickel		
	27	Electric	2 switches	682M27T52C	Nickel		

* If you wish to order copies of the same key or masterkeying, just add KA or AM at the end of each reference.

* In the case of masterkeyings, only available for MKS extensions.

TD5 Cylinder



Technical Data

TD5 is a PATENTED cylinder that covers the basic segment of the TESA range with a cost-benefit balanced solution for master keyed installations.

Characteristics

- » Type: Sawn key (Brass nickel plated).
- » Number of rows: 1
- » Number of pins: 5
- » Technology: Tumbler
- » Permutation level: Grade 2
- » Corrosion Resistance: Grade B
- » Pick protection: Medium level
- » Lifespan: 100.000 test cycles
- » 3 keys per cylinder

Options

- » Finishes: Brass/Nickel plated
- » Cam: DIN R15 and R13
- » Number of pins: 5
- » Formats available: Master keyed
- » Patent protection: TD5 cylinder is patent protected on the key and cylinder.
- » Wide size and profile range.

Master keyed system

The platform which supports its manufacturing combine 5pins with 10 heights per position. TD5 cylinder includes a MULTIPRO-FILE tree to face master key systems with total working guarantee, increasing by 4 the monoprofile MKS combinatory.

Mks capacity in monoprofile

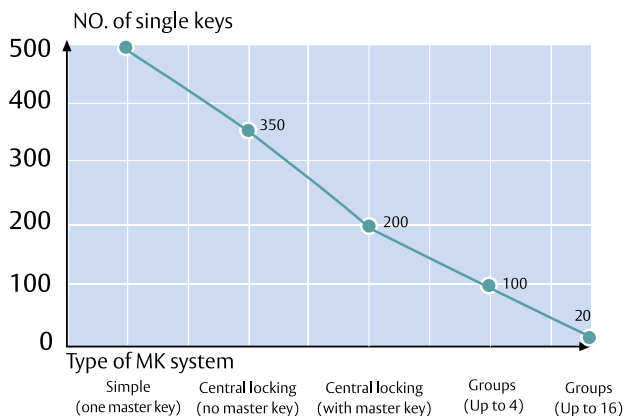

Security **	Masterkeying ** **
----------------	--------------------------



European standard regulation

In the same way as the main models included in the catalogue, TD5 is certified according to the European standard regulation.

	1	5	0	1	0	B	2	0
Key resistance (Grade 0-1)								
Lifespan (Grade 4-6)								
Door mass (Not applied in cylinder)								
Fire resistance (Grade 0-1)								
Safety of the people (Not applied in cylinders)								
Corrosion and temperature resistance (Grade 0-A-B-C)								
Key related security (Grade 1 to 6)								
Attack resistance (Grade 0 to 2)								

Recommendations

- » Use lubricant to lengthen the maximum lifespan of the cylinder.
- » Use only ORIGINAL TESA KEYS.
- » For safety reasons, when you install a new cylinder, remember that once installed, it should not project more than 1mm.



Standard cylinder TD5



European profile

50 uds. (L≤90)
30 uds. (L>90)

Double european		L	A	B	Cam = 15 mm	Finish	Short cam Cam = 13,2 mm	Finish	
	60	30	30	TD535 30 30 L	Brass	MD530 30 30 N	Brass		
	65	30	35	TD535 30 35 L	Brass	MD530 30 35 N	Brass		
	70	30	40	TD535 30 40 L	Brass	MD530 30 40 N	Brass		
	70	35	35	TD535 35 35 L	Brass	MD530 35 35 N	Brass		
	75	30	45	TD535 30 45 L	Brass	MD530 30 45 N	Brass		
	75	35	40	TD535 35 40 L	Brass	MD530 35 40 N	Brass		
	80	30	50	TD535 30 50 L	Brass	MD530 30 50 N	Brass		
	80	35	45	TD535 35 45 L	Brass	MD530 35 45 N	Brass		
	80	40	40	TD535 40 40 L	Brass	MD530 40 40 N	Brass		
	85	35	50	TD535 35 50 L	Brass	MD530 35 50 N	Brass		
	90	30	60	TD535 30 60 L	Brass	MD530 30 60 N	Brass		
	90	35	55	TD535 35 55 L	Brass	MD530 35 55 N	Brass		
	90	40	50	TD535 40 50 L	Brass	MD530 40 50 N	Brass		
	90	45	45	TD535 45 45 L	Brass	MD530 45 45 N	Brass		
	100	30	70	TD535 30 70 L	Brass	MD530 30 70 N	Brass		
	100	40	60	TD535 40 60 L	Brass	MD530 40 60 N	Brass		
100	50	50	TD535 50 50 L	Brass	MD530 50 50 N	Brass			
110	30	80	TD535 30 80 L	Brass	MD530 30 80 N	Brass			
110	50	60	TD535 50 60 L	Brass	MD530 50 60 N	Brass			
120	30	90	TD535 30 90 L	Brass	MD530 30 90 N	Brass			
120	40	80	TD535 40 80 L	Brass	MD530 40 80 N	Brass			
120	60	60	TD535 60 60 L	Brass	MD530 60 60 N	Brass			
130	30	100	TD535 31 00 L	Brass	MD530 31 00 N	Brass			
140	40	100	TD535 41 00 L	Brass	MD530 41 00 N	Brass			
150	50	100	TD535 51 00 L	Brass	MD530 51 00 N	Brass			
160	60	100	TD535 61 00 L	Brass	MD530 61 00 N	Brass			
Single european		L	A	B	Cam = 15 mm	Finish	Cam = 13,2 mm	Finish	
	40	30	10	TD535 30 10 L	Brass	MD530 30 10 N	Brass		
	45	35	10	TD535 35 10 L	Brass	MD530 35 10 N	Brass		
	50	40	10	TD535 40 10 L	Brass	MD530 40 10 N	Brass		
	60	50	10	TD535 50 10 L	Brass	MD530 50 10 N	Brass		
	70	60	10	TD535 60 10 L	Brass	MD530 60 10 N	Brass		
	80	70	10	TD535 70 10 L	Brass	MD530 70 10 N	Brass		
	90	80	10	TD535 80 10 L	Brass	MD530 80 10 N	Brass		
	100	90	10	TD535 90 10 L	Brass	MD530 90 10 N	Brass		
	Knob european		L	A	B	Cam = 15 mm	Finish	Cam = 13,2 mm	Finish
		60	30	30	TD53B 30 30 L	Brass	MD53B 30 30 N	Brass	
65		30	35	TD53B 30 35 L	Brass	MD53B 30 35 N	Brass		
70		35	35	TD53B 35 35 L	Brass	MD53B 35 35 N	Brass		
70		40	30	TD53B 40 30 L	Brass	MD53B 40 30 N	Brass		
80		30	50	TD53B 30 50 L	Brass	MD53B 30 50 N	Brass		
80		40	40	TD53B 40 40 L	Brass	MD53B 40 40 N	Brass		
85		35	50	TD53B 35 50 L	Brass	MD53B 35 50 N	Brass		
90		30	60	TD53B 30 60 L	Brass	MD53B 30 60 N	Brass		
90		45	45	TD53B 45 45 L	Brass	MD53B 45 45 N	Brass		

* If you wish to order copies of the same key or masterkeying, just add KA or AM at the end of each reference.

* In the case of masterkeyings, only available for MKS extensions.

Standard cylinder TD5



European profile

Padlock exchangeable	L	A	B	Product code	Finish
	-	-	-	TD53CL55L	Brass
	-	-	-	TD53CL55N	Nickel
<hr/>					
Adjustable cam. Single profile (8 positions)	L	A	B	Product code	Finish
	40	30	10	TD53W3010L	Brass
	40	30	10	TD53W3010N	Nickel
<hr/>					
Adjustable european cylinder	L	A	B	Product code	Finish
	40	30	10	TD5R3010L	Brass
	40	30	10	TD5R3010N	Nickel
	50	40	10	TD5R4010L	Brass
	50	40	10	TD5R4010N	Nickel
<hr/>					

Round profiles

Model 5000	Ø	Inside length	Outside length	Product code	Finish
	28	26 mm	26 mm	500000LT	Brass
	<hr/>				
Adjustable round cylinder	Ø	Inside length	Outside length	Product code	Finish
	27	-	Adjustable	55TE00LT	Brass
	27	-	Adjustable	55TE00LN	Nickel
<hr/>					
Round for AUMON locks	Ø	Inside length	Outside length	Product code	Finish
	26	-	Adjustable	T53REGAUHL	Brass
	26	-	Adjustable	T53REGAUHN	Nickel
<hr/>					
Accessories	Lenght	Product code	Finish		
TUBE	22	TUB2526L22L	Brass		
TUBE	22	TUB2526L22N	Nickel		

* If you wish to order copies of the same key or masterkeying, just add KA or AM at the end of each reference.

* In the case of masterkeyings, only available for MKS extensions.



Standard cylinder TD5

Round profiles

682			Metric	Type	Function	Product code	Finish
	23	Mechanic	-	682M23T5NM	Nickel		
	23	Electric	1 switch & return	682M23T5CR	Nickel		
	27	Mechanic	-	682M27T5NM	Nickel		
	27	Electric	1 switch	682M27T51C	Nickel		
	27	Electric	1 switch & return	682M27T5CR	Nickel		
	27	Electric	2 switches	682M27T52C	Nickel		

* If you wish to order copies of the same key or masterkeying, just add KA or AM at the end of each reference.

* In the case of masterkeyings, only available for MKS extensions.

Security cylinder T60

Technical data

It is a reversible dimple key system which covers basic security levels.

Characteristics

- » Type: Dimple key. (Brass nickel plated).
- » Number of rows: 1
- » Number of pins: 6
- » Combination level: Grade 5
- » Technology: Tumbler regular.
- » Corrosion resistance: Grade B.
- » Anti pick system.
- » Drill resistant.
- » Bump proof cylinder lock.
- » Lifespan: 100,000 test cycles.
- » 3 / 5 keys per cylinder.
- » Conform to EN-1303 regulation

Options

- » Double security clutch.
- » Modular. (For unusual measures o anti snap protection)
- » Cams: DIN R15, R13 and different pinion gears.
- » Finishes: Brass / Nickel plated.
- » Formats available: Key different, mater keyed, key alike and specific codes.
- » Wide size and profile range.

Masterkey systems

The platform that supports its manufacturing makes it possible to combine a maximum number of 7 heights per position. The T60 is a suitable system for Masterkey systems where complexity levels are not too high.

ONLY AVAILABLE FOR ADDITIONS

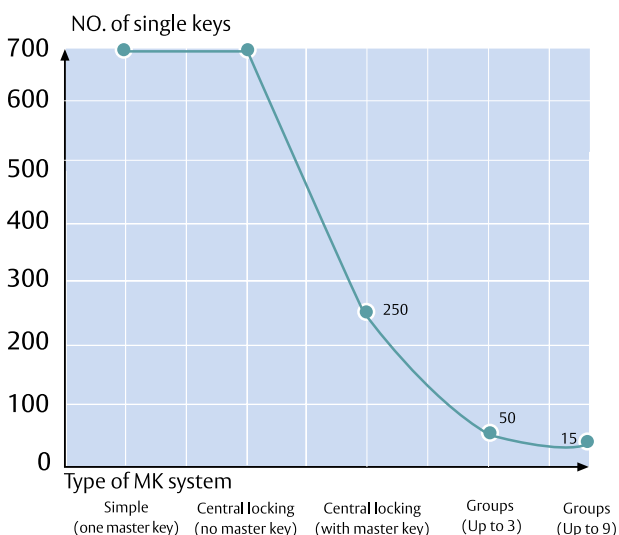

Security	Masterkeying
**	**



European standard regulation.

T60 is certified according to the standard EN 1303 regulation, getting the following results.

1	6	0	1	0	B	5	0
Key resistance (Grade 0-1)	Lifespan (Grade 4-6)	Door mass (Not applied in cylinder)	Fire resistance (Grade 0-1)	Safety of the people (Not applied in cylinders)	Corrosion and temperature resistance (Grade 0-A-B-C)	Key related security (Grade 1 to 6)	Attack resistance (Grade 0 to 2)

Recommendations

- » Use TESA lubricant to lengthen the maximum lifespan of the cylinder.
- » Use original keys to make copies.
- » For safety reasons, when you select a new cylinder, remember that once installed, it should not project more than 1mm.



Security cylinder T60

European profile

32 uds. (L≤90)
30 uds. (L>90)

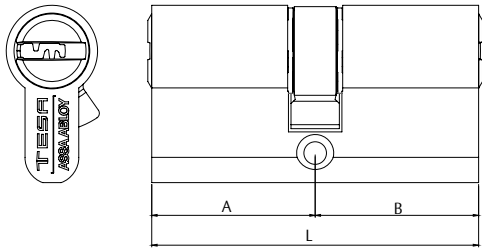
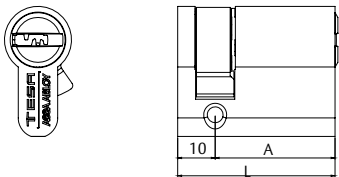
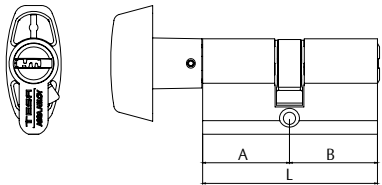
Double european		L	A	B	Cam = 15 mm	Finish	Short cam Cam = 13,2 mm	Finish	
		60	30	30	T655 30 30 L	Brass	M650 30 30 N	Nickel	
		65	30	35	T655 30 35 L	Brass	M650 30 35 N	Nickel	
		70	30	40	T655 30 40 L	Brass	M650 30 40 N	Nickel	
		70	35	35	T655 35 35 L	Brass	M650 35 35 N	Nickel	
		75	30	45	T655 30 45 L	Brass	M650 30 45 N	Nickel	
		75	35	40	T655 35 40 L	Brass	M650 35 40 N	Nickel	
		80	30	50	T655 30 50 L	Brass	M650 30 50 N	Nickel	
		80	35	45	T655 35 45 L	Brass	M650 35 45 N	Nickel	
		80	40	40	T655 40 40 L	Brass	M650 40 40 N	Nickel	
		85	35	50	T655 35 50 L	Brass	M650 35 50 N	Nickel	
		90	30	60	T655 30 60 L	Brass	M650 30 60 N	Nickel	
		90	35	55	T655 35 55 L	Brass	M650 35 55 N	Nickel	
		90	40	50	T655 40 50 L	Brass	M650 40 50 N	Nickel	
		90	45	45	T655 45 45 L	Brass	M650 45 45 N	Nickel	
		100	30	70	T655 30 70 L	Brass	M650 30 70 N	Nickel	
		100	40	60	T655 40 60 L	Brass	M650 40 60 N	Nickel	
		100	50	50	T655 50 50 L	Brass	M650 50 50 N	Nickel	
		110	30	80	T655 30 80 L	Brass	M650 30 80 N	Nickel	
		110	50	60	T655 50 60 L	Brass	M650 50 60 N	Nickel	
		120	30	90	T655 30 90 L	Brass	M650 30 90 N	Nickel	
	120	40	80	T655 40 80 L	Brass	M650 40 80 N	Nickel		
	120	60	60	T655 60 60 L	Brass	M650 60 60 N	Nickel		
	130	30	100	T655 31 00 L	Brass	M650 31 00 N	Nickel		
	140	40	100	T655 41 00 L	Brass	M650 41 00 N	Nickel		
	150	50	100	T655 51 00 L	Brass	M650 51 00 N	Nickel		
	160	60	100	T655 61 00 L	Brass	M650 61 00 N	Nickel		
Single european		L	A	B	Cam = 15 mm	Finish	Cam = 13,2 mm	Finish	
		40	30	10	T655 30 10 L	Brass	M650 30 10 N	Nickel	
		45	35	10	T655 35 10 L	Brass	M650 35 10 N	Nickel	
		50	40	10	T655 40 10 L	Brass	M650 40 10 N	Nickel	
		60	50	10	T655 50 10 L	Brass	M650 50 10 N	Nickel	
		70	60	10	T655 60 10 L	Brass	M650 60 10 N	Nickel	
		80	70	10	T655 70 10 L	Brass	M650 70 10 N	Nickel	
		90	80	10	T655 80 10 L	Brass	M650 80 10 N	Nickel	
		100	90	10	T655 90 10 L	Brass	M650 90 10 N	Nickel	
	Knob european		L	A	B	Cam = 15 mm	Finish	Cam = 13,2 mm	Finish
			60	30	30	T65B 30 30 L	Brass	M65B 30 30 N	Nickel
		65	30	35	T65B 30 35 L	Brass	M65B 30 35 N	Nickel	
		70	35	35	T65B 35 35 L	Brass	M65B 35 35 N	Nickel	
		70	40	30	T65B 40 30 L	Brass	M65B 40 30 N	Nickel	
		80	30	50	T65B 30 50 L	Brass	M65B 30 50 N	Nickel	
		80	40	40	T65B 40 40 L	Brass	M65B 40 40 N	Nickel	
		85	35	50	T65B 35 50 L	Brass	M65B 35 50 N	Nickel	
		90	30	60	T65B 30 60 L	Brass	M65B 30 60 N	Nickel	
		90	45	45	T65B 45 45 L	Brass	M65B 45 45 N	Nickel	

* If you wish to order copies of the same key or masterkeying, just add KA or AM at the end of each reference.

* In the case of Masterkey systems, only available for MKS extensions.

* In order to choose the finish, select 'L' for brass or 'N' for nickel as the last letter in the code.

* The brass-plated finish in R13 is only available for sizes up to 80mm.

Security cylinder T60

European profile

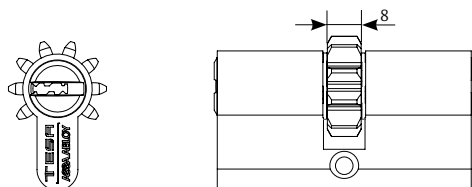

These part numbers are assembled with a 10 teeth pinion gear and outside diameter of 24 mm. The clutch housing is aligned with the tooth. They are not compatible with double security clutch.

European double with 10 teeth pinion gear							
L	A	B	Pinion Z10 D24	Finish	Pinion Z10 D24	Finish	
60	30	30	T65P3030L	Brass	T65P3030N	Nickel	
64	32	32	T65P3232L	Brass	T65P3232N	Nickel	
70	30	40	T65P3040L	Brass	T65P3040N	Nickel	
74	32	42	T65P3242L	Brass	T65P3242N	Nickel	
75	35	40	T65P3540L	Brass	T65P3540N	Nickel	

European modular							
L	A	B	Exc. = 15 mm	Finish	Exc. = 15 mm	Finish	
140	--	--	T655140LMD	Brass	T655140NMD	Nickel	
145	--	--	T655145LMD	Brass	T655145NMD	Nickel	
150	--	--	T655150LMD	Brass	T655150NMD	Nickel	
155	--	--	T655155LMD	Brass	T655155NMD	Nickel	
160	--	--	T655160LMD	Brass	T655160NMD	Nickel	
165	--	--	T655165LMD	Brass	T655165NMD	Nickel	
170	--	--	T655170LMD	Brass	T655170NMD	Nickel	
175	--	--	T655175LMD	Brass	T655175NMD	Nickel	
180	--	--	T655180LMD	Brass	T655180NMD	Nickel	
185	--	--	T655185LMD	Brass	T655185NMD	Nickel	
190	--	--	T655190LMD	Brass	T655190NMD	Nickel	
195	--	--	T655195LMD	Brass	T655195NMD	Nickel	
200	--	--	T655200LMD	Brass	T655200NMD	Nickel	

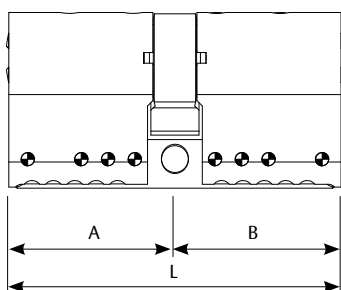

These part numbers are for modular cylinders assembled from the factory. Measurements for side A and B will be required when processing an order. The Cam, only if it is different to the standard (R15).

Eu European modular heads (to be used with the modular cases)							
L	A	B	-	Finish	-	Finish	
30	30	--	T60530LMD	Brass	T60530NMD	Nickel	
45	45	--	T60545LMD	Brass	T60545NMD	Nickel	
60	30	30	T60560LMD	Brass	T60560NMD	Nickel	
75	30	45	T60575LMD	Brass	T60575NMD	Nickel	
90	45	45	T60590LMD	Brass	T60590NMD	Nickel	

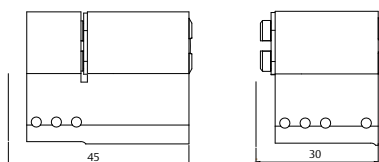

* If you wish to order copies of the same key or masterkeying, just add KA or AM at the end of each reference.

* In the case of Masterkey systems, only available for MKS extensions.

* In order to choose the finish, select 'L' for brass or 'N' for nickel as the last letter in the code.

* The brass-plated finish in R13 is only available for sizes up to 80mm.



Security cylinder T60

European profile

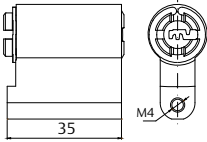
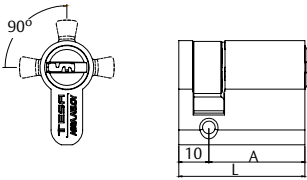
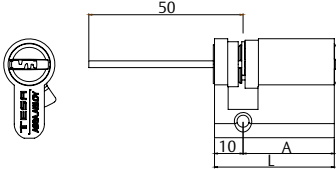
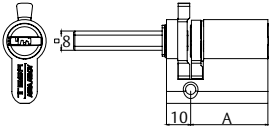
Padlock exchangeable	L	A	B	Product code	Finish
	-	-	-	T65CL55L	Brass
	-	-	-	T65CL55N	Nickel
Adjustable cam. Single profile (4 positions)	L	A	B	Product code	Finish
	40	30	10	T65W3010L	Brass
	40	30	10	T65W3010N	Nickel
Adjustable european cylinder	L	A	B	Product code	Finish
	40	30	10	T65R3010L	Brass
	40	30	10	T65R3010N	Nickel
	50	40	10	T65R4010L	Brass
	50	40	10	T65R4010N	Nickel
Euro cylinder for lock set 3520	L	A	B	Product code	Finish
	40	30	10	T652520L	Brass
	40	30	10	T652520N	Nickel

* If you wish to order copies of the same key or masterkeying, just add KA or AM at the end of each reference.

* In the case of Masterkey systems, only available for MKS extensions.

* In order to choose the finish, select 'L' for brass or 'N' for nickel as the last letter in the code.

* The brass-plated finish in R13 is only available for sizes up to 80mm.

Security cylinder T60

Round profiles

Round for TS lock sets		Ø	Inside length	Outside length	Product code	Finish
Inside		28	30	45	T6TS40LC	Brass
		28	30	45	T6TS40LT	Brass
Outside						
The ref. LC includes external shield and fixing plate.						

Round for TS lock sets		Ø	Inside length	Outside length	Product code	Finish
Inside		28	30	Regulable	T6TSRFLC	Brass
		28	30	Regulable	T6TSRFLT	Brass
Outside						
The ref. LC includes external shield and fixing plate.						

Adjustable round cylinder		Ø	Inside length	Outside length	Product code	Finish
		28	-	Regulable	55T605LT	Brass
		28	-	Regulable	55T605LN	Nickel

* If you wish to order copies of the same key or masterkeying, just add KA or AM at the end of each reference.

* In the case of Masterkey systems, only available for MKS extensions.

D

Security cylinder T60

Round profiles

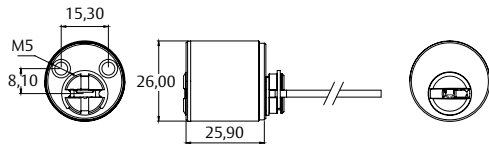

Part number with "H" = AUMON / Serraller = "V"

Round for AUMON & Serraller locks	Ø	Inside length	Outside length	Product code	Finish
	26	-	Adjustable	T65REGAUHL	Brass
	26	-	Adjustable	T65REGAUHN	Nickel
	26	-	Adjustable	T65REGAUVL	Brass
	26	-	Adjustable	T65REGAUVN	Nickel
Accessories	Lenght			Product code	Finish
TUBE	22			TUB2526L22L	Brass
TUBE	22			TUB2526L22N	Nickel

* If you wish to order copies of the same key or masterkeying, just add KA or AM at the end of each reference.

* In the case of Masterkey systems, only available for MKS extensions.

Security cylinder T60

Round profiles

682		Metric	Type	Function	Product code	Finish
	23	Metric	Mechanic	-	682M23T6NM	
	23	Metric	Electric	1 switch & return	682M23T6CR	Nickel
	27	Metric	Mechanic	-	682T6NM	Nickel
	27	Metric	Electric	1 micro switch	682T61C	Nickel
	27	Metric	Electric	1 switch & return	682T6CR	Nickel
	27	Metric	Electric	2 micro switches	682T62C	Nickel

* If you wish to order copies of the same key or masterkeying, just add KA or AM at the end of each reference.

* In the case of Masterkey systems, only available for MKS extensions.

D

Security cylinder TD60



Technical Data

The TD60 is a PATENTED cylinder that covers the medium range of TESA cylinders with a solution based on security and combinatory, ideal for masterkeyed installations that require a balanced solution in terms of features and costs.

Security ** **	Masterkeying ** **
----------------------	--------------------------



Features

- » Type of key: dimple reversible (Nickel-plated brass)
- » Number of rows: 1
- » Number of pins: 6
- » Technology: Tumbler
- » Combinatory: Degree 5
- » Corrosion Resistance and T^o: Degree B
- » Antipick: Medium level
- » Durability: 100,000 cycles.
- » 5 PATENTED keys per cylinder.

Options

- » Finishes: Brass/Nickel
- » Cams: DIN R15 or R13
- » Available formats: Masterkey systems.
- » Patent: The TD60 features a patent in the key and the cylinder.
- » A wide range of sizes and profiles.

System for Masterkey systems

The TD60 has 6 pins with 7 heights configuration. It includes a MULTIKEYWAY tree that allows the user to ensure the correct operation of Masterkey systems that require higher capacity - the capacity is four times higher than with the single-keyway model.

Regulations

As well as the main models featured in TESA's catalogue, the TD60 has been certified according to tests specified by European standards.

1	6	0	1	0	B	5	0
Key resistance (Grade 0-1)	Lifespan (Grade 4-6)	Door mass (Not applied in cylinder)	Fire resistance (Grade 0-1)	Safety of the people (Not applied in cylinders)	Corrosion and temperature resistance (Grade 0-A-B-C)	Key related security (Grade 1 to 6)	Attack resistance (Grade 0 to 2)

* Note; With an E700 escutcheon, antisnap resistance reaches degree 2.

Combinatory capacity for single-keyway:

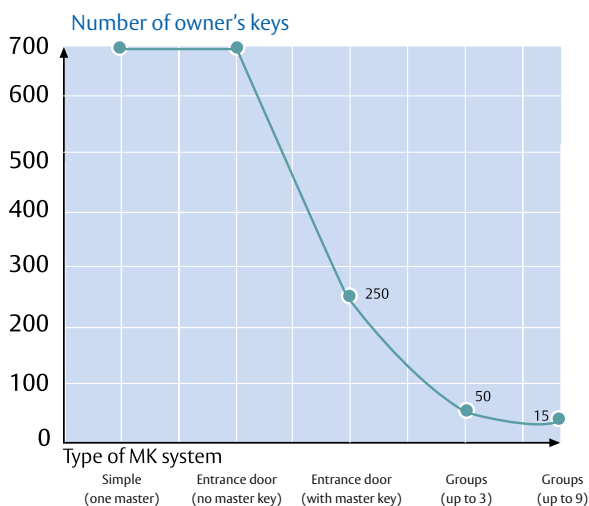

Recommendations

- » Always use TESA lubricant in order to increase the service life of the cylinder.
- » Use only original blank keys for your copies.
- » For security reasons, every time you replace or recommend a cylinder size please note that, once it has been installed, it must not protrude more than 1 mm.



Security cylinder TD60

European profile

32 units (L≤90)
30 units (L>90)

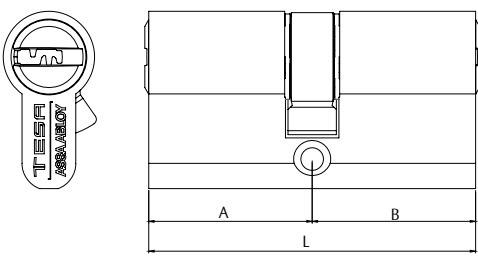
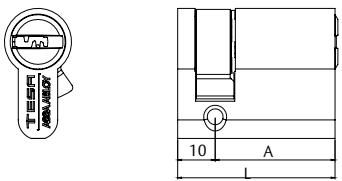
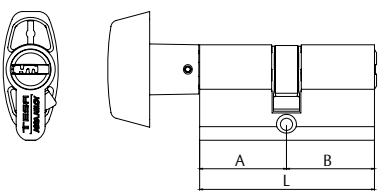
Double european		L	A	B	Cam = 15 mm	Finish	Short cam Cam = 13,2 mm	Finish	
		60	30	30	TD655 30 30 L	Brass	MD650 30 30 N	Nickel	
		65	30	35	TD655 30 35 L	Brass	MD650 30 35 N	Nickel	
		70	30	40	TD655 30 40 L	Brass	MD650 30 40 N	Nickel	
		70	35	35	TD655 35 35 L	Brass	MD650 35 35 N	Nickel	
		75	30	45	TD655 30 45 L	Brass	MD650 30 45 N	Nickel	
		75	35	40	TD655 35 40 L	Brass	MD650 35 40 N	Nickel	
		80	30	50	TD655 30 50 L	Brass	MD650 30 50 N	Nickel	
		80	35	45	TD655 35 45 L	Brass	MD650 35 45 N	Nickel	
		80	40	40	TD655 40 40 L	Brass	MD650 40 40 N	Nickel	
		85	35	50	TD655 35 50 L	Brass	MD650 35 50 N	Nickel	
		90	30	60	TD655 30 60 L	Brass	MD650 30 60 N	Nickel	
		90	35	55	TD655 35 55 L	Brass	MD650 35 55 N	Nickel	
		90	40	50	TD655 40 50 L	Brass	MD650 40 50 N	Nickel	
		90	45	45	TD655 45 45 L	Brass	MD650 45 45 N	Nickel	
		100	30	70	TD655 30 70 L	Brass	MD650 30 70 N	Nickel	
		100	40	60	TD655 40 60 L	Brass	MD650 40 60 N	Nickel	
	100	50	50	TD655 50 50 L	Brass	MD650 50 50 N	Nickel		
	110	30	80	TD655 30 80 L	Brass	MD650 30 80 N	Nickel		
	110	50	60	TD655 50 60 L	Brass	MD650 50 60 N	Nickel		
	120	30	90	TD655 30 90 L	Brass	MD650 30 90 N	Nickel		
	120	40	80	TD655 40 80 L	Brass	MD650 40 80 N	Nickel		
	120	60	60	TD655 60 60 L	Brass	MD650 60 60 N	Nickel		
	130	30	100	TD655 31 00 L	Brass	MD650 31 00 N	Nickel		
	140	40	100	TD655 41 00 L	Brass	MD650 41 00 N	Nickel		
	150	50	100	TD655 51 00 L	Brass	MD650 51 00 N	Nickel		
	160	60	100	TD655 61 00 L	Brass	MD650 61 00 N	Nickel		
Single european		L	A	B	Cam = 15 mm	Finish	Cam = 13,2 mm	Finish	
		40	30	10	TD655 30 10 L	Brass	MD650 30 10 N	Nickel	
		45	35	10	TD655 35 10 L	Brass	MD650 35 10 N	Nickel	
		50	40	10	TD655 40 10 L	Brass	MD650 40 10 N	Nickel	
		60	50	10	TD655 50 10 L	Brass	MD650 50 10 N	Nickel	
		70	60	10	TD655 60 10 L	Brass	MD650 60 10 N	Nickel	
		80	70	10	TD655 70 10 L	Brass	MD650 70 10 N	Nickel	
		90	80	10	TD655 80 10 L	Brass	MD650 80 10 N	Nickel	
		100	90	10	TD655 90 10 L	Brass	MD650 90 10 N	Nickel	
	Knob european		L	A	B	Cam = 15 mm	Finish	Cam = 13,2 mm	Finish
			60	30	30	TD65B 30 30 L	Brass	MD65B 30 30 N	Nickel
		65	30	35	TD65B 30 35 L	Brass	MD65B 30 35 N	Nickel	
		70	35	35	TD65B 35 35 L	Brass	MD65B 35 35 N	Nickel	
		70	40	30	TD65B 40 30 L	Brass	MD65B 40 30 N	Nickel	
		80	30	50	TD65B 30 50 L	Brass	MD65B 30 50 N	Nickel	
		80	40	40	TD65B 40 40 L	Brass	MD65B 40 40 N	Nickel	
		85	35	50	TD65B 35 50 L	Brass	MD65B 35 50 N	Nickel	
		90	30	60	TD65B 30 60 L	Brass	MD65B 30 60 N	Nickel	
		90	45	45	TD65B 45 45 L	Brass	MD65B 45 45 N	Nickel	

* If you wish to order copies of the same key or masterkeying, just add KA or AM at the end of each reference.

* In order to choose the finish, select 'L' for brass or 'N' for nickel as the last letter in the code.

* The brass-plated finish in R13 is only available for sizes up to 80mm.

D

Security cylinder TD60

European profile

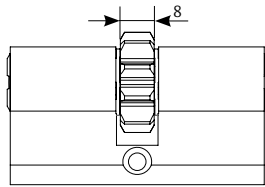
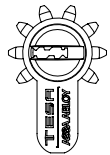

European double with 10 teeth pinion gear

L	A	B	Pinion Z10 D24	Finish	Pinion Z10 D24	Finish
60	30	30	TD65P3030L	Brass	TD65P3030N	Nickel
64	32	32	TD65P3232L	Brass	TD65P3232N	Nickel
70	30	40	TD65P3040L	Brass	TD65P3040N	Nickel
74	32	42	TD65P3242L	Brass	TD65P3242N	Nickel
75	35	40	TD65P3540L	Brass	TD65P3540N	Nickel

These part numbers are assembled with a 10 teeth pinion gear and outside diameter of 24 mm. The clutch housing is aligned with the tooth. They are not compatible with double security clutch.

European modular

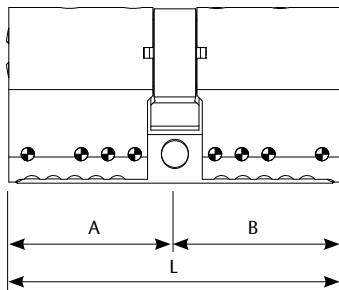

These part numbers are for modular cylinders assembled from the factory. Measurements for side A and B will be required when processing an order. The Cam, only if it is different to the standard (R15).

L	A	B	Exc. = 15 mm	Finish	Exc. = 15 mm	Finish
140	--	--	TD655140LMD	Brass	TD655140NMD	Nickel
145	--	--	TD655145LMD	Brass	TD655145NMD	Nickel
150	--	--	TD655150LMD	Brass	TD655150NMD	Nickel
155	--	--	TD655155LMD	Brass	TD655155NMD	Nickel
160	--	--	TD655160LMD	Brass	TD655160NMD	Nickel
165	--	--	TD655165LMD	Brass	TD655165NMD	Nickel
170	--	--	TD655170LMD	Brass	TD655170NMD	Nickel
175	--	--	TD655175LMD	Brass	TD655175NMD	Nickel
180	--	--	TD655180LMD	Brass	TD655180NMD	Nickel
185	--	--	TD655185LMD	Brass	TD655185NMD	Nickel
190	--	--	TD655190LMD	Brass	TD655190NMD	Nickel
195	--	--	TD655195LMD	Brass	TD655195NMD	Nickel
200	--	--	TD655200LMD	Brass	TD655200NMD	Nickel

European modular heads (to be used with the modular cases)

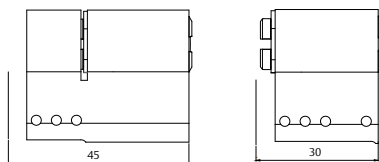

L	A	B	-	Finish	-	Finish
30	30	--	T60530LMD	Brass	T60530NMD	Nickel
45	45	--	T60545LMD	Brass	T60545NMD	Nickel
60	30	30	T60560LMD	Brass	T60560NMD	Nickel
75	30	45	T60575LMD	Brass	T60575NMD	Nickel
90	45	45	T60590LMD	Brass	T60590NMD	Nickel

* If you wish to order copies of the same key or masterkeying, just add KA or AM at the end of each reference.

* In order to choose the finish, select 'L' for brass or 'N' for nickel as the last letter in the code.

* The brass-plated finish in R13 is only available for sizes up to 80mm.

Security cylinder TD60

European profile

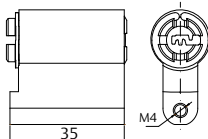
Padlock exchangeable	L	A	B	Product code	Finish
	-	-	-	TD65CL55L	Brass
	-	-	-	TD65CL55N	Nickel

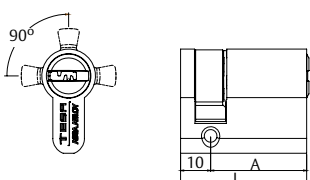
Adjustable cam. Single profile (4 positions)	L	A	B	Product code	Finish
	40	30	10	TD65W3010L	Brass
	40	30	10	TD65W3010N	Nickel

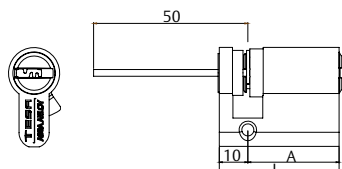
Adjustable european cylinder	L	A	B	Product code	Finish
	40	30	10	TD65R3010L	Brass
	40	30	10	TD65R3010N	Nickel
	50	40	10	TD65R4010L	Brass
	50	40	10	TD65R4010N	Nickel

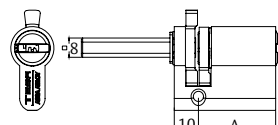
Euro cylinder for lock set 3520	L	A	B	Product code	Finish
	40	30	10	TD652520L	Brass
	40	30	10	TD652520N	Nickel

* If you wish to order copies of the same key or masterkeying, just add KA or AM at the end of each reference.

* In order to choose the finish, select 'L' for brass or 'N' for nickel as the last letter in the code.

* The brass-plated finish in R13 is only available for sizes up to 80mm.

D

Security cylinder TD60

Round profiles

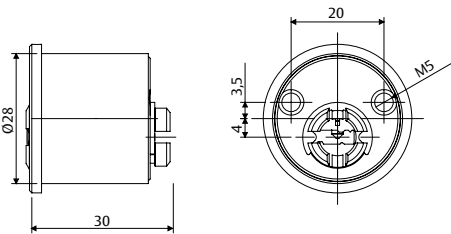
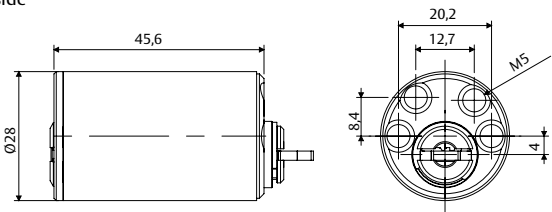
Round for TS lock sets		Ø	Inside length	Outside length	Product code	Finish
Inside		28	30	45	T6TS40LC	Brass
		28	30	45	T6TS40LT	Brass
Outside						
The ref. LC includes external shield and fixing plate.						

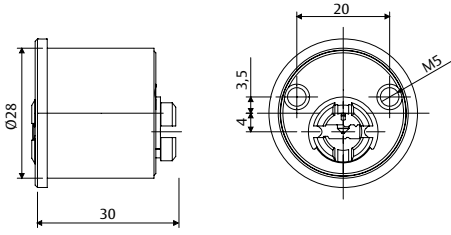
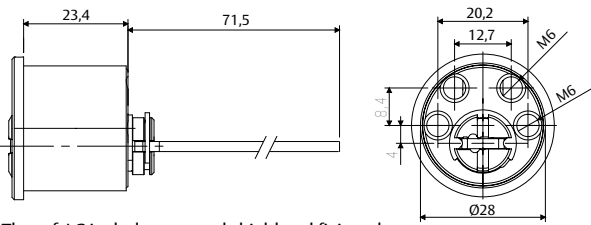
Round for TS lock sets		Ø	Inside length	Outside length	Product code	Finish
Inside		28	30	Regulable	T6TSRFLC	Brass
		28	30	Regulable	T6TSRFLT	Brass
Outside						
The ref. LC includes external shield and fixing plate.						

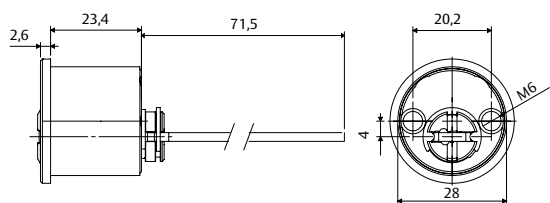
Adjustable round cylinder		Ø	Inside length	Outside length	Product code	Finish
		28	-	Regulable	55T605LT	Brass
		28	-	Regulable	55T605LN	Nickel

* To process "master keyed" and "key alike" orders add either AM or KA in each part number, respectively.

T70 Anti-Snap Cylinder

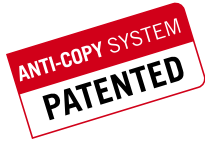

Technical details

The T70 cylinder has been specially designed to provide a guaranteed solution against SNAP attacks, while also providing efficient anti-extraction, anti-bump and anti-drill protection.

The (patented) head of the key presents a special configuration that makes it compatible with NARROW HEAD escutcheons.

The cylinder's security is also supported by a patent, ensuring that the key can not be duplicated.

Features

Basic

- » Type of key: Flat, non-duplicable and patented.
- » Number of rows: 1
- » Number of pins: 6+1 security sensor in the cylinder.
- » Combinatory: Degree 5
- » Resistance to corrosion and temperature: Degree B
- » Durability: 100,000 cycles

Anti-Tampering Protection

- » Double ANTI-SNAP protection:
 - via fuse slot
 - via reinforced steel bar
- » ANTIBUMP system
- » Anti-pick protection
- » Anti-drill protection: DEGREE 2
- » Anti-extraction protection: DEGREE 2

Narrow Head

- » Special configuration of the (patented) head of the key. Compatible with narrow-profile escutcheons.

Key protection

- » Patented key and cylinder.
- » Key duplication and cylinders are protected by property card.

Certification

- » Certificated according to EN1303

Options

- » Brass and nickel-chromed finishes
- » Cams: R15 and R13.
- » Optional: cylinders in KD and key alike. Not available in master keying.
- » Europrofile range, padlock and 682 and adjustable round shape.

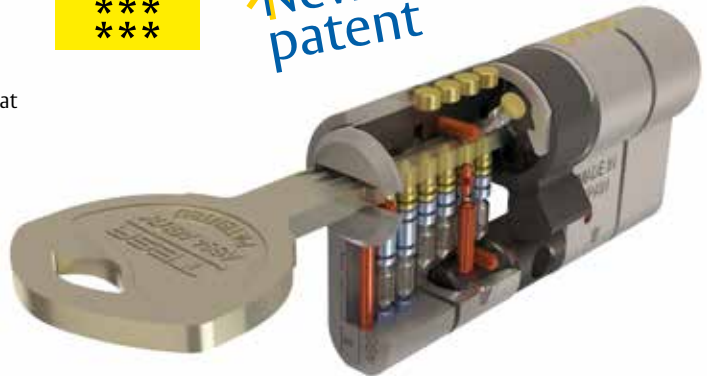

Regulations

As well as the main models featured in TESA's catalogue, the T70 has been certified according to tests specified by European standards.

1	6	0	1	0	B	5	2
Resistance of the key (Degree 0-1)	Durability (Degree 4 to 6)	Door mass and locking force (Not applicable for cylinders)	Apt for use with fire break doors (Degree 0-1)	Personal safety (Not applicable for cylinders)	High resistance to corrosion and temperature (Degrees 0, A, B, C)	Security of the key (Degree 1 to 6)	Anti-tampering resistance (Degree 0 to 2)

Recommendations

- » Use TESA lubrication for an optimum service life of the cylinder.
- » Always keep the ownership card in order to make copies of the keys.
- » Follow the mounting instructions supplied with the cylinder for the correct mounting of the product.



Security cylinder T70

European profile

32 units (L≤90)
30 units (L>90)

T70 Double european

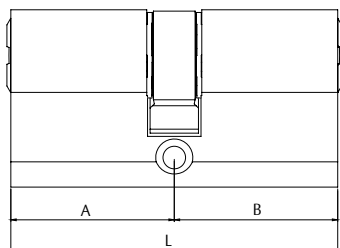

L	A	B	Cam = 15 mm	Finish	Short cam Cam = 13,2 mm	Finish
60	30	30	T7 55 30 30 L	Brass	M7 55 30 30 L	Brass
60	30	30	T7 55 30 30 N	Nickel	M7 55 30 30 N	Nickel
70	35	35	T7 55 35 35 L	Brass	M7 55 35 35 L	Brass
70	35	35	T7 55 35 35 N	Nickel	M7 55 35 35 N	Nickel
70	30	40	T7 55 30 40 L	Brass	M7 55 30 40 L	Brass
70	30	40	T7 55 30 40 N	Nickel	M7 55 30 40 N	Nickel
75	35	40	T7 55 35 40 L	Brass	M7 55 35 40 L	Brass
75	35	40	T7 55 35 40 N	Nickel	M7 55 35 40 N	Nickel
80	35	45	T7 55 35 45 L	Brass	M7 55 35 45 L	Brass
80	35	45	T7 55 35 45 N	Nickel	M7 55 35 45 N	Nickel
80	30	50	T7 55 30 50 L	Brass	M7 55 30 50 L	Brass
80	30	50	T7 55 30 50 N	Nickel	M7 55 30 50 N	Nickel
80	40	40	T7 55 40 40 L	Brass	M7 55 40 40 L	Brass
80	40	40	T7 55 40 40 N	Nickel	M7 55 40 40 N	Nickel
85	35	50	T7 55 35 50 L	Brass	M7 55 35 50 L	Brass
85	35	50	T7 55 35 50 N	Nickel	M7 55 35 50 N	Nickel
85	40	45	T7 55 40 45 L	Brass	M7 55 40 45 L	Brass
85	40	45	T7 55 40 45 N	Nickel	M7 55 40 45 N	Nickel
90	35	55	T7 55 35 55 L	Brass	M7 55 35 55 L	Brass
90	35	55	T7 55 35 55 N	Nickel	M7 55 35 55 N	Nickel
90	40	50	T7 55 40 50 L	Brass	M7 55 40 50 L	Brass
90	40	50	T7 55 40 50 N	Nickel	M7 55 40 50 N	Nickel
90	45	45	T7 55 45 45 L	Brass	M7 55 45 45 L	Brass
90	45	45	T7 55 45 45 N	Nickel	M7 55 45 45 N	Nickel
95	40	55	T7 55 40 55 L	Brass	M7 55 40 55 L	Brass
95	40	55	T7 55 40 55 N	Nickel	M7 55 40 55 N	Nickel
95	45	50	T7 55 45 50 L	Brass	M7 55 45 50 L	Brass
95	45	50	T7 55 45 50 N	Nickel	M7 55 45 50 N	Nickel
100	40	60	T7 55 40 60 L	Brass	M7 55 40 60 L	Brass
100	40	60	T7 55 40 60 N	Nickel	M7 55 40 60 N	Nickel
100	45	55	T7 55 45 55 L	Brass	M7 55 45 55 L	Brass
100	45	55	T7 55 45 55 N	Nickel	M7 55 45 55 N	Nickel
100	50	50	T7 55 50 50 L	Brass	M7 55 50 50 L	Brass
100	50	50	T7 55 50 50 N	Nickel	M7 55 50 50 N	Nickel

T70 Single european

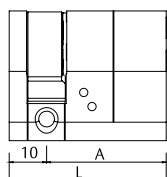

L	A	B	Exc. = 15 mm	Finish	Short cam Cam = 13,2 mm	Finish
60	30	30	T7 5B 30 30 L	Brass	M7 5B 30 30 L	Brass
60	30	30	T7 5B 30 30 N	Nickel	M7 5B 30 30 N	Nickel
70	35	35	T7 5B 35 35 L	Brass	M7 5B 35 35 L	Brass
70	35	35	T7 5B 35 35 N	Nickel	M7 5B 35 35 N	Nickel
80	40	40	T7 5B 40 40 L	Brass	M7 5B 40 40 L	Brass
80	40	40	T7 5B 40 40 N	Nickel	M7 5B 40 40 N	Nickel
90	40	50	T7 5B 40 50 L	Brass	M7 5B 40 50 L	Brass
90	40	50	T7 5B 40 50 N	Nickel	M7 5B 40 50 N	Nickel

T70 Knob european

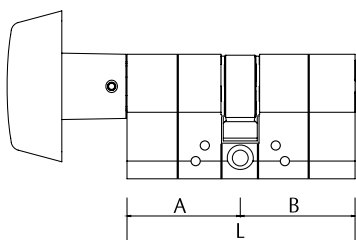

L	A	B	Exc. = 15 mm	Finish	Short cam Cam = 13,2 mm	Finish
40	30	10	T7 55 30 10 L	Brass	M7 55 30 10 L	Brass
40	30	10	T7 55 30 10 N	Nickel	M7 55 30 10 N	Nickel
45	35	10	T7 55 35 10 L	Brass	M7 55 35 10 L	Brass
45	35	10	T7 55 35 10 N	Nickel	M7 55 35 10 N	Nickel
50	40	10	T7 55 40 10 L	Brass	M7 55 40 10 L	Brass
50	40	10	T7 55 40 10 N	Nickel	M7 55 40 10 N	Nickel
55	45	10	T7 55 45 10 L	Brass	M7 55 45 10 L	Brass
55	45	10	T7 55 45 10 N	Nickel	M7 55 45 10 N	Nickel
60	50	10	T7 55 50 10 L	Brass	M7 55 50 10 L	Brass
60	50	10	T7 55 50 10 N	Nickel	M7 55 50 10 N	Nickel

* To process "master keyed" and "cylinders alike" orders add either AM or KA in each part number, respectively.

Security cylinder T70

European profile

 24 units (L<100)

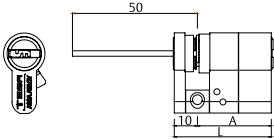
Adjustable european cylinder		L	A	B	Exc. = 15 mm	Finish	Short cam Cam = 13,2 mm	Finish
	40	30	10	T7 5R 30 10 L	Brass	M7 5R 30 10 L	Brass	
	40	30	10	T7 5R 30 10 N	Nickel	M7 5R 30 10 N	Nickel	
	50	40	10	T7 5R 40 10 L	Brass	M7 5R 40 10 L	Brass	
	50	40	10	T7 5R 40 10 N	Nickel	M7 5R 40 10 N	Nickel	

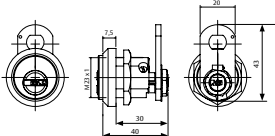
T70 Profile type 682 M23 electric and mechanical		L	A	B	Exc. = 15 mm	Finish	Short cam Cam = 13,2 mm	Finish
	ELEC	23	1+RET	682M23T7CR	Nickel	682M23M7CR	Nickel	
	MEC	23	NA	682M23T7NM	Nickel	682M23M7NM	Nickel	

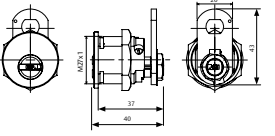
T70 Profile type 682 M27 electric and mechanical		L	A	B	Exc. = 15 mm	Finish	Short cam Cam = 13,2 mm	Finish
	ELEC	27	1	682T71C	Nickel	682M71C	Nickel	
	ELEC	27	2	682T72C	Nickel	682M72C	Nickel	
	ELEC	27	1+RET	682T7CR	Nickel	682M7CR	Nickel	
	MEC	27	NA	682T7NM	Nickel	682M7NM	Nickel	

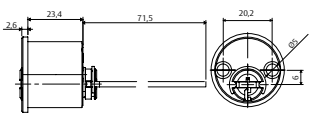
T70 Adjustable round cylinder		L	A	B	Exc. = 15 mm	Finish	Short cam Cam = 13,2 mm	Finish
	28			55 T7 03 LN	Nickel	55 M7 03 LN	Nickel	
	28			55 T7 03 LT	Brass	55 M7 03 LT	Brass	
	28			55 T7 05 LN	Nickel	55 M7 05 LN	Nickel	
	28			55 T7 05 LT	Brass	55 M7 05 LT	Brass	

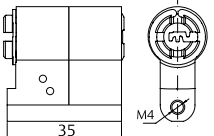
T70 Padlock exchangeable		L	A	B	Exc. = 15 mm	Finish	Short cam Cam = 13,2 mm	Finish
	35	35		T75CL55 L	Brass	M7 5CL55L	Brass	
	35	35		T75CL55 N	Nickel	M7 5CL55N	Nickel	

* If you wish to order copies of the same key or masterkeying, just add KA or AM at the end of each reference.

D

Security cylinder T80

Technical data

Reversible dimple key with open key blank distribution.

Characteristics

- » Type: Dimple key. (Nickel silver).
- » Number of rows: 2
- » Number of pins: 8
- » Combination level: Grade 6
- » Technology: Tumbler regular.
- » Corrosion resistance: Grade B.
- » Anti pick cylinder lock
- » Drill resistant.
- » Bump proof model.
- » Lifespan: 100,000 test cycles.
- » 3 / 5 keys per cylinder.
- » Conform to EN-1303 regulation

Options

- » Double security clutch.
- » Modular. (Specially designed for either unusual measurements or anti snap protection)
- » Cams: DIN R15, R13.
- » Finishes: Brass / Nickel.
- » Formats available: Key different, master keyed, key alike and specific codes.
- » A wide range of sizes and profiles.

Master key systems

The eight position chambers and the possibility of varying side pins makes T80 the most suitable option for those master key systems where the number of key functions is large and the copy control is not required.

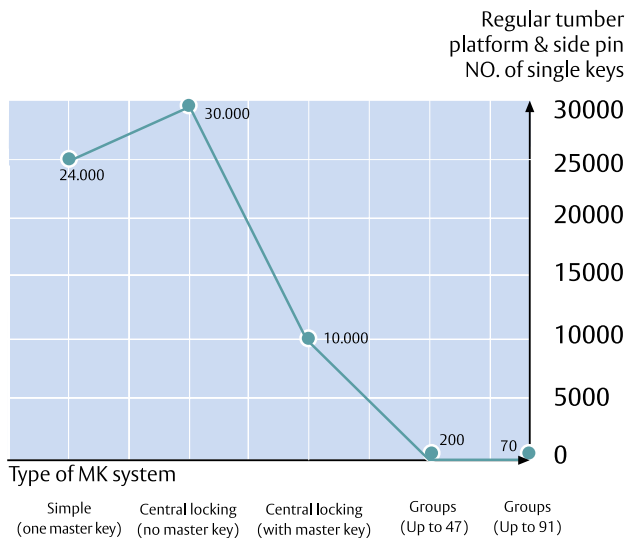

Recommendations

- » Use TESA lubricant to lengthen the maximum lifespan of the cylinder.
- » Use original keys to make copies.
- » For safety reasons, when you select a new cylinder, remember that once installed, it should not project more than 1mm.



Security cylinder T80

European profile

 32 units (L≤90)
30 units (L>90)

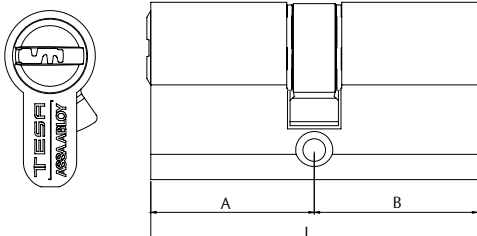
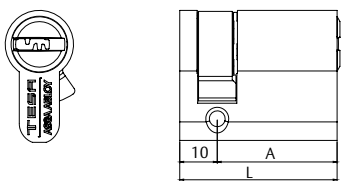
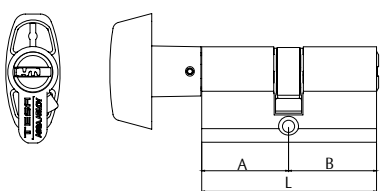
Double european		L	A	B	Cam = 15 mm	Finish	Short cam Cam = 13,2 mm	Finish	
		60	30	30	T855 30 30 L	Brass	M850 30 30 N	Nickel	
		65	30	35	T855 30 35 L	Brass	M850 30 35 N	Nickel	
		70	30	40	T855 30 40 L	Brass	M850 30 40 N	Nickel	
		70	35	35	T855 35 35 L	Brass	M850 35 35 N	Nickel	
		75	30	45	T855 30 45 L	Brass	M850 30 45 N	Nickel	
		75	35	40	T855 35 40 L	Brass	M850 35 40 N	Nickel	
		80	30	50	T855 30 50 L	Brass	M850 30 50 N	Nickel	
		80	35	45	T855 35 45 L	Brass	M850 35 45 N	Nickel	
		80	40	40	T855 40 40 L	Brass	M850 40 40 N	Nickel	
		85	35	50	T855 35 50 L	Brass	M850 35 50 N	Nickel	
		90	30	60	T855 30 60 L	Brass	M850 30 60 N	Nickel	
		90	35	55	T855 35 55 L	Brass	M850 35 55 N	Nickel	
		90	40	50	T855 40 50 L	Brass	M850 40 50 N	Nickel	
		90	45	45	T855 45 45 L	Brass	M850 45 45 N	Nickel	
		100	30	70	T855 30 70 L	Brass	M850 30 70 N	Nickel	
		100	40	60	T855 40 60 L	Brass	M850 40 60 N	Nickel	
		100	50	50	T855 50 50 L	Brass	M850 50 50 N	Nickel	
		110	30	80	T855 30 80 L	Brass	M850 30 80 N	Nickel	
		110	50	60	T855 50 60 L	Brass	M850 50 60 N	Nickel	
		120	30	90	T855 30 90 L	Brass	M850 30 90 N	Nickel	
	120	40	80	T855 40 80 L	Brass	M850 40 80 N	Nickel		
	120	60	60	T855 60 60 L	Brass	M850 60 60 N	Nickel		
	130	30	100	T855 31 00 L	Brass	M850 31 00 N	Nickel		
	140	40	100	T855 41 00 L	Brass	M850 41 00 N	Nickel		
	150	50	100	T855 51 00 L	Brass	M850 51 00 N	Nickel		
	160	60	100	T855 61 00 L	Brass	M850 61 00 N	Nickel		
Single european		L	A	B	Cam = 15 mm	Finish	Cam = 13,2 mm	Finish	
		40	30	10	T855 30 10 L	Brass	M850 30 10 N	Nickel	
		45	35	10	T855 35 10 L	Brass	M850 35 10 N	Nickel	
		50	40	10	T855 40 10 L	Brass	M850 40 10 N	Nickel	
		60	50	10	T855 50 10 L	Brass	M850 50 10 N	Nickel	
		70	60	10	T855 60 10 L	Brass	M850 60 10 N	Nickel	
		80	70	10	T855 70 10 L	Brass	M850 70 10 N	Nickel	
		90	80	10	T855 80 10 L	Brass	M850 80 10 N	Nickel	
		100	90	10	T855 90 10 L	Brass	M850 90 10 N	Nickel	
	Knob European		L	A	B	Cam = 15 mm	Finish	Cam = 13,2 mm	Finish
			60	30	30	T85B 30 30 L	Brass	M85B 30 30 N	Nickel
		65	30	35	T85B 30 35 L	Brass	M85B 30 35 N	Nickel	
		70	35	35	T85B 35 35 L	Brass	M85B 35 35 N	Nickel	
		70	40	30	T85B 40 30 L	Brass	M85B 40 30 N	Nickel	
		80	30	50	T85B 30 50 L	Brass	M85B 30 50 N	Nickel	
		80	40	40	T85B 40 40 L	Brass	M85B 40 40 N	Nickel	
		85	35	50	T85B 35 50 L	Brass	M85B 35 50 N	Nickel	
		90	30	60	T85B 30 60 L	Brass	M85B 30 60 N	Nickel	
		90	45	45	T85B 45 45 L	Brass	M85B 45 45 N	Nickel	

* If you wish to order copies of the same key or masterkeying, just add KA or AM at the end of each reference.

* Brass-plated finish in R13 NOT AVAILABLE

D

Security cylinder T80

European profile

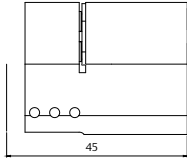
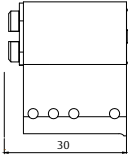
European modular heads (to be used with the modular cases)		L	A	B	-	Finish	-	Finish
		30	30	--	T80530LMD	Brass	T80530NMD	Nickel
		45	45	--	T80545LMD	Brass	T80545NMD	Nickel
		60	30	30	T80560LMD	Brass	T80560NMD	Nickel
		75	30	45	T80575LMD	Brass	T80575NMD	Nickel
		90	45	45	T80590LMD	Brass	T80590NMD	Nickel

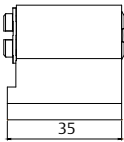
Padlock exchangeable		L	A	B	Product code	Finish
		-	-	-	T85CL55L	Brass
		-	-	-	T85CL55N	Nickel

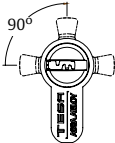
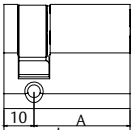
Adjustable cam. Single profile (4 positions)		L	A	B	Product code	Finish
		40	30	10	T85W3010L	Brass
		40	30	10	T85W3010N	Nickel

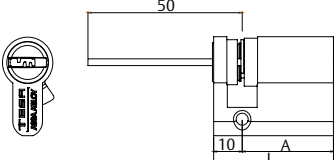
Adjustable european cylinder		L	A	B	Product code	Finish
		40	30	10	T85R3010L	Brass
		40	30	10	T85R3010N	Nickel
		50	40	10	T85R4010L	Brass
		50	40	10	T85R4010N	Nickel

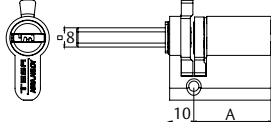
Euro cylinder for lock set 3520.		L	A	B	Product code	Finish
		40	30	10	T852520L	Brass
		40	30	10	T852520N	Nickel

* To process "master keyed" and "key alike" orders add either AM or KA in each part number, respectively.

Security cylinder T80

Round profiles

Round for TS lock sets		Ø	Inside length	Outside length	Product code	Finish
Inside		28	30	45	T8TS40LC	Brass
		28	30	45	T8TS40LT	Brass
Outside						

The ref. LC includes external shield and fixing plate.

Round for TS lock sets		Ø	Inside length	Outside length	Product code	Finish
Inside		28	30	Adjustable	T8TSRFLC	Brass
		28	30	Adjustable	T8TSRFLT	Brass
Outside						

The ref. LC includes external shield and fixing plate.

Adjustable round cylinder		Ø	Inside length	Outside length	Product code	Finish
Inside		28	-	Adjustable	55T805LT	Brass
		28	-	Adjustable	55T805LN	Nickel
Outside						

* To process "master keyed" and "key alike" orders add either AM or KA in each part number, respectively.



Security cylinder T80

Round profiles

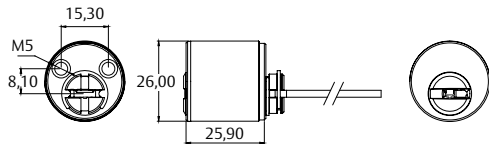

* Tubes to extend the length of the cylinder are sold apart
Part number with "H" = AUMON / Serraller = "V"

Round for AUMON & Serraller locks		Ø	Inside length	Outside length	Product code	Finish
		26	-	Adjustable	T85REGAUHL	Brass
		26	-	Adjustable	T85REGAUHN	Nickel
		26	-	Adjustable	T85REGAUVL	Brass
		26	-	Adjustable	T85REGAUVN	Nickel
Accessories	Lenght				Product code	Finish
TUBE	22				TUB2526L22L	Brass
TUBE	22				TUB2526L22N	Nickel

Security cylinder T80

Round profiles

682		Metric	Type	Function	Product code	Finish
	23	Mechanic	-	682M23TSNM	Nickel	
	23	Electric	1 switch & return	682M23TSCR	Nickel	
	27	Mechanic	-	682T8NM	Nickel	
	27	Electric	1 micro switch	682T81C	Nickel	
	27	Electric	1 switch & return	682T8CR	Nickel	
	27	Electric	2 micro switches	682T82C	Nickel	

* To process "master keyed" and "cylinders alike" orders add either AM or KA in each part number, respectively.

D

High security cylinder TK6



Technical data

New model designed to cover two basic necessities in the market. On the one hand has been made with an exclusive and patented combination technology to solve complex master key suites and on the other hand a new security sensor lets the owner control all the keys in one installation.

Characteristics

- » Type: Patented sawn key with security sensor.
- » Number of rows: 1
- » Number of pins: 6.
- » Technology: DROP ORBITAL (Exclusive TESA rights)
- » Permutation level: Grade 6.
- » Corrosion resistance: Grade B
- » Anti pick cylinder lock (High resistance.)
- » Bump proof system.
- » Drill protection grade 1.
- » 3 patented keys made of nickel silver.
- » Conform to EN-1303 regulation.
- » Lifespan: 100,000 test cycles.
- » Master key systems: Medium capability in combination with DROP ORBITAL platform.

Options

- » Finishes: Brass / Nickel.
- » Cam: DIN R15 and R13
- » Formats available: Key different, mater keyed, key alike and specific codes.
- » A wide range of sizes and profiles.
- » Colour points to differentiate master key levels.

Master key system

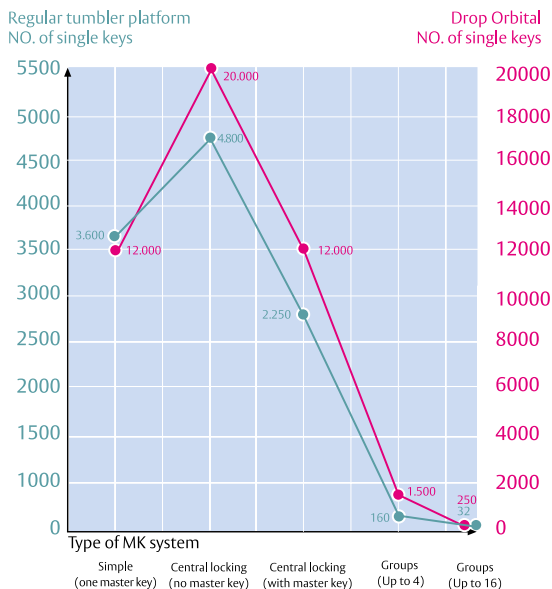

European standard regulation

In the same way as the main models included in the catalogue, the TK6 is certified according to the European standard regulation.

1	6	0	1	0	B	6	0
Key resistance (Grade 0-1)	Lifespan (Grade 4-6)	Door mass (Not applied in cylinder)	Fire resistance (Grade 0-1)	Safety of the people (Not applied in cylinders)	Corrosion and temperature resistance (Grade 0-A-B-C)	Key related security (Grade 1 to 6)	Attack resistance (Grade 0 to 2)

*Note: with the shield E700 the attack resistance rise to the level 2.

Recommendations

- » Use TESA lubricant to lengthen the maximum lifespan of the cylinder.
- » TESA recommends to the user of the TK6 to keep the property card in a safe and secure location. Only by presenting this card, can one obtain key and cylinder copies.
- » For safety reasons, when you install a new cylinder, remember that once installed, it should not project more than 1mm.



High security cylinder TK6

Patented

European profile

 32 units (L≤90)
30 units (L>90)

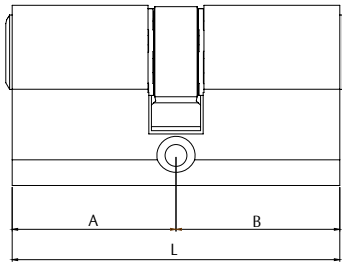
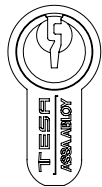

European profile

L	A	B	Cam = 15 mm	Finish	Short cam Cam = 13,2 mm	Finish
60	30	30	AK635 30 30 L	Brass	AK63M 30 30 N	Nickel
65	30	35	AK635 30 35 L	Brass	AK63M 30 35 N	Nickel
70	30	40	AK635 30 40 L	Brass	AK63M 30 40 N	Nickel
70	35	35	AK635 35 35 L	Brass	AK63M 35 35 N	Nickel
75	30	45	AK635 30 45 L	Brass	AK63M 30 45 N	Nickel
75	35	40	AK635 35 40 L	Brass	AK63M 35 40 N	Nickel
80	30	50	AK635 30 50 L	Brass	AK63M 30 50 N	Nickel
80	35	45	AK635 35 45 L	Brass	AK63M 35 45 N	Nickel
80	40	40	AK635 40 40 L	Brass	AK63M 40 40 N	Nickel
85	35	50	AK635 35 50 L	Brass	AK63M 35 50 N	Nickel
90	30	60	AK635 30 60 L	Brass	AK63M 30 60 N	Nickel
90	35	55	AK635 35 55 L	Brass	AK63M 35 55 N	Nickel
90	40	50	AK635 40 50 L	Brass	AK63M 40 50 N	Nickel
90	45	45	AK635 45 45 L	Brass	AK63M 45 45 N	Nickel
100	30	70	AK635 30 70 L	Brass	AK63M 30 70 N	Nickel
100	40	60	AK635 40 60 L	Brass	AK63M 40 60 N	Nickel
100	50	50	AK635 50 50 L	Brass	AK63M 50 50 N	Nickel
110	30	80	AK635 30 80 L	Brass	AK63M 30 80 N	Nickel
110	50	60	AK635 50 60 L	Brass	AK63M 50 60 N	Nickel
120	30	90	AK635 30 90 L	Brass	AK63M 30 90 N	Nickel
120	40	80	AK635 40 80 L	Brass	AK63M 40 80 N	Nickel
120	60	60	AK635 60 60 L	Brass	AK63M 60 60 N	Nickel
130	30	100	AK635 31 00 L	Brass	AK63M 31 00 N	Nickel
140	40	100	AK635 41 00 L	Brass	AK63M 41 00 N	Nickel
150	50	100	AK635 51 00 L	Brass	AK63M 51 00 N	Nickel
160	60	100	AK635 61 00 L	Brass	AK63M 61 00 N	Nickel

Single european

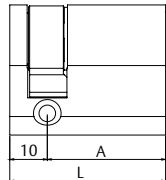

L	A	B	Cam = 15 mm	Finish	Cam = 13,2 mm	Finish
40	30	10	AK635 30 10 L	Brass	AK63M 30 10 N	Nickel
45	35	10	AK635 35 10 L	Brass	AK63M 35 10 N	Nickel
50	40	10	AK635 40 10 L	Brass	AK63M 40 10 N	Nickel
60	50	10	AK635 50 10 L	Brass	AK63M 50 10 N	Nickel
70	60	10	AK635 60 10 L	Brass	AK63M 60 10 N	Nickel
80	70	10	AK635 70 10 L	Brass	AK63M 70 10 N	Nickel
90	80	10	AK635 80 10 L	Brass	AK63M 80 10 N	Nickel
100	90	10	AK635 90 10 L	Brass	AK63M 90 10 N	Nickel

Knob european.

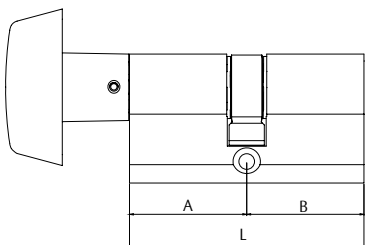

L	A	B	Cam = 15 mm	Finish	Cam = 13,2 mm	Finish
60	30	30	AK63B 30 30 L	Brass	AK63MB 30 30 N	Nickel
65	30	35	AK63B 30 35 L	Brass	AK63MB 30 35 N	Nickel
70	35	35	AK63B 35 35 L	Brass	AK63MB 35 35 N	Nickel
70	40	30	AK63B 40 30 L	Brass	AK63MB 40 30 N	Nickel
80	30	50	AK63B 30 50 L	Brass	AK63MB 30 50 N	Nickel
80	40	40	AK63B 40 40 L	Brass	AK63MB 40 40 N	Nickel
85	35	50	AK63B 35 50 L	Brass	AK63MB 35 50 N	Nickel
90	30	60	AK63B 30 60 L	Brass	AK63MB 30 60 N	Nickel
90	45	45	AK63B 45 45 L	Brass	AK63MB 45 45 N	Nickel

* To process "master keyed" and "key alike" orders add either AM or KA in each part number, respectively.

D

High security cylinder TK6

Patented

European profile

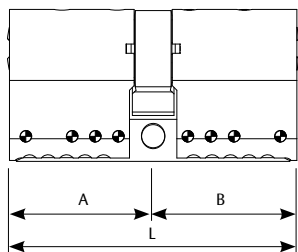

These part numbers are for modular cylinders assembled from the factory. Measurements for side A and B will be required when processing an order. The Cam, only if it is different to the standard (15 mm).

Europeo modular			L	A	B	Leva = 15 mm	Finish	Leva = 15 mm	Finish
			145	--	--	AK635145LMD	Brass	AK635145NMD	Nickel
			150	--	--	AK635150LMD	Brass	AK635150NMD	Nickel
			155	--	--	AK635155LMD	Brass	AK635155NMD	Nickel
			160	--	--	AK635160LMD	Brass	AK635160NMD	Nickel
			165	--	--	AK635165LMD	Brass	AK635165NMD	Nickel
			170	--	--	AK635170LMD	Brass	AK635170NMD	Nickel
			175	--	--	AK635175LMD	Brass	AK635175NMD	Nickel
			180	--	--	AK635180LMD	Brass	AK635180NMD	Nickel
			185	--	--	AK635185LMD	Brass	AK635185NMD	Nickel
			190	--	--	AK635190LMD	Brass	AK635190NMD	Nickel
			195	--	--	AK635195LMD	Brass	AK635195NMD	Nickel
			200	--	--	AK635200LMD	Brass	AK635200NMD	Nickel

European modular heads (to be used with the modular cases)

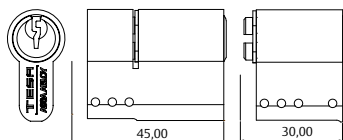

L	A	B	Leva = 15 mm	Finish	Leva = 15 mm	Finish
30	30	--	AK6330LMD	Brass	AK6330NMD	Nickel
45	45	--	AK6345LMD	Brass	AK6345NMD	Nickel
60	30	30	AK6360LMD	Brass	AK6360NMD	Nickel
75	30	45	AK6375LMD	Brass	AK6375NMD	Nickel
90	45	45	AK6390LMD	Brass	AK6390NMD	Nickel

Padlock exchangeable

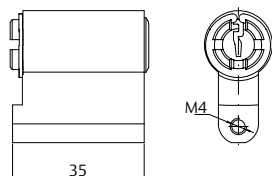

L	A	B	Product code	Finish
-	-	-	AK63CL55L	Brass
-	-	-	AK63CL55N	Nickel

Adjustable cam. Single profile (8 positions)

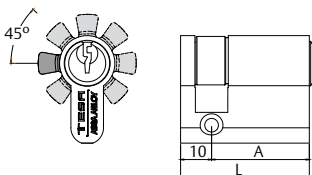

L	A	B	Product code	Finish
40	30	10	AK63W3010L	Brass
40	30	10	AK63W3010N	Nickel

Adjustable tail. Single profile

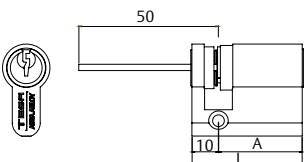

L	A	B	Product code	Finish
40	30	10	AK63R3010L	Brass
40	30	10	AK63R3010N	Nickel
50	40	10	AK63R4010L	Brass
50	40	10	AK63R4010N	Nickel

* To process "master keyed" and "key alike" orders add either AM or KA in each part number, respectively.

High security cylinder TK6

Patented

Round profiles

Adjustable round cylinder		Ø	Inside length	Outside length	Product code	Finish
		28	-	Adjustable	55AK63LT	Brass
		28	-	Adjustable	55AK63NM	Nickel

682		Metric	Type	Fonction	Product code	Finish
		23	Mechanic	-	AK6682M23NM	Nickel
		23	Electric	1 switch & return	AK6682M23CR	Nickel

		27	Mechanic	-	AK6682M27NM	Nickel
		27	Electric	1 switch & return	AK6682M27CR	Nickel

* To process "master keyed" and "key alike" orders add either AM or KA in each part number, respectively.

D

High security cylinder TX80



Technical data

Tx80 cylinders have been designed according to the highest quality protection systems. It is a model in constant evolution that incorporates the most advanced security developments (bumping, picking...etc). A design thought to offer to the user the higher security grade in all its extension.

Characteristics

- » Type: Patented dimple key with security sensor.
- » Number of rows: 2
- » Number of pins: 8
- » Technology: Tumbler regular.
- » Permutation level: Grade 6.
- » Corrosion resistance: Grade B
- » Anti pick cylinder lock (High resistance.)
- » Bump proof system.
- » Drill protection grade 2.
- » Lifespan: 100,000 test cycles.
- » Key copies protected with security card.
- » Clutch of double security.
- » 5 patented keys made of nickel silver.
- » Conform to EN-1303 regulation.
- » Master key systems: High capability using side pins and multi profile key ways.

Options

- » Finishes: Brass / Nickel.
- » Cam: DIN R15 and R13.
- » Formats available: Key different, mater keyed, key alike and specific codes.
- » A wide range of sizes and profiles.
- » Colour points to differentiate master key levels.

Master key systems

The patented character of the system will let the owner control, in every moment, the key copies thanks to the property card provided with each cylinder or master key suite.

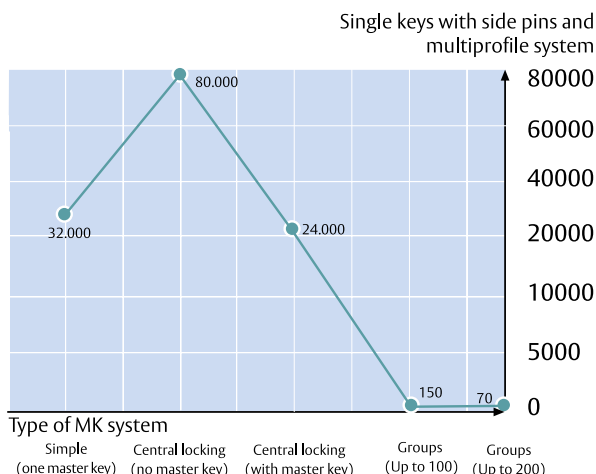

European standard regulation

In the same way as the main models included in the catalogue, TX80 is certified according to the European standard regulation.

1	6	0	1	0	B	6	2
Key resistance (Grade 0-1)	Lifespan (Grade 4-6)	Door mass (Not applied in cylinder)	Fire resistance (Grade 0-1)	Safety of the people (Not applied in cylinders)	Corrosion and temperature resistance (Grade 0-A-B-C)	Key related security (Grade 1 to 6)	Attack resistance (Grade 0 to 2)

*Note; with the shield E700 the attack resistance rise to the level 2.

Recommendations

- » Use TESA lubricant to lengthen the maximum lifespan of the cylinder.
- » TESA recommends to the user of the TX80 to keep the property card in a safe and secure location. Only by presenting this card, can one obtain key and cylinder copies.
- » For safety reasons, when you install a new cylinder, remember that once installed, it should not project more than 1mm.



The patented nature of the system allows the owner of the installation to monitor at all times the copies of keys and/or cylinders being done.

High security cylinder TX80

Patented

European profile

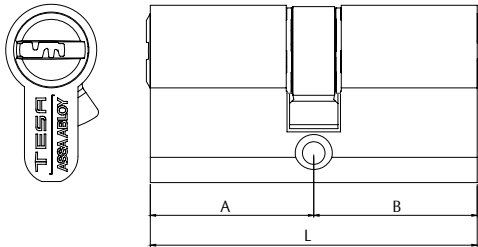
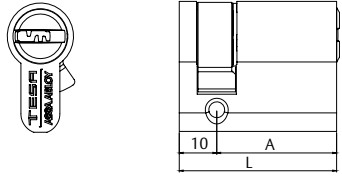
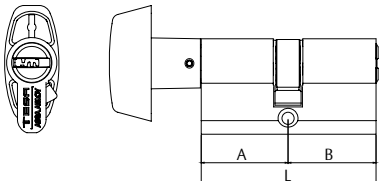
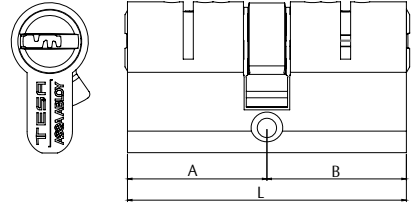

Double european		L	A	B	Cam = 15 mm	Finish	Short cam Cam = 13,2 mm	Finish
		60	30	30	TX85 30 30 L	Brass	MX80 30 30 N	Nickel
		65	30	35	TX85 30 35 L	Brass	MX80 30 35 N	Nickel
		70	30	40	TX85 30 40 L	Brass	MX80 30 40 N	Nickel
		70	35	35	TX85 35 35 L	Brass	MX80 35 35 N	Nickel
		75	30	45	TX85 30 45 L	Brass	MX80 30 45 N	Nickel
		75	35	40	TX85 35 40 L	Brass	MX80 35 40 N	Nickel
		80	30	50	TX85 30 50 L	Brass	MX80 30 50 N	Nickel
		80	35	45	TX85 35 45 L	Brass	MX80 35 45 N	Nickel
		80	40	40	TX85 40 40 L	Brass	MX80 40 40 N	Nickel
		85	35	50	TX85 35 50 L	Brass	MX80 35 50 N	Nickel
		90	30	60	TX85 30 60 L	Brass	MX80 30 60 N	Nickel
		90	35	55	TX85 35 55 L	Brass	MX80 35 55 N	Nickel
		90	40	50	TX85 40 50 L	Brass	MX80 40 50 N	Nickel
		90	45	45	TX85 45 45 L	Brass	MX80 45 45 N	Nickel
		100	30	70	TX85 30 70 L	Brass	MX80 30 70 N	Nickel
		100	40	60	TX85 40 60 L	Brass	MX80 40 60 N	Nickel
		100	50	50	TX85 50 50 L	Brass	MX80 50 50 N	Nickel
		110	30	80	TX85 30 80 L	Brass	MX80 30 80 N	Nickel
		110	50	60	TX85 50 60 L	Brass	MX80 50 60 N	Nickel
		120	30	90	TX85 30 90 L	Brass	MX80 30 90 N	Nickel
		120	40	80	TX85 40 80 L	Brass	MX80 40 80 N	Nickel
		120	60	60	TX85 60 60 L	Brass	MX80 60 60 N	Nickel
		130	30	100	TX85 31 00 L	Brass	MX80 31 00 N	Nickel
		140	40	100	TX85 41 00 L	Brass	MX80 41 00 N	Nickel
		150	50	100	TX85 51 00 L	Brass	MX80 51 00 N	Nickel
		160	60	100	TX85 61 00 L	Brass	MX80 61 00 N	Nickel
Single european		L	A	B	Cam = 15 mm	Finish	Cam = 13,2 mm	Finish
		40	30	10	TX85 30 10 L	Brass	MX80 30 10 N	Nickel
		45	35	10	TX85 35 10 L	Brass	MX80 35 10 N	Nickel
		50	40	10	TX85 40 10 L	Brass	MX80 40 10 N	Nickel
		60	50	10	TX85 50 10 L	Brass	MX80 50 10 N	Nickel
		70	60	10	TX85 60 10 L	Brass	MX80 60 10 N	Nickel
		80	70	10	TX85 70 10 L	Brass	MX80 70 10 N	Nickel
		90	80	10	TX85 80 10 L	Brass	MX80 80 10 N	Nickel
		100	90	10	TX85 90 10 L	Brass	MX80 90 10 N	Nickel
Knob european		L	A	B	Cam = 15 mm	Finish	Cam = 13,2 mm	Finish
		60	30	30	TX8B 30 30 L	Brass	MX8B 30 30 N	Nickel
		65	30	35	TX8B 30 35 L	Brass	MX8B 30 35 N	Nickel
		70	35	35	TX8B 35 35 L	Brass	MX8B 35 35 N	Nickel
		70	40	30	TX8B 40 30 L	Brass	MX8B 40 30 N	Nickel
		80	30	50	TX8B 30 50 L	Brass	MX8B 30 50 N	Nickel
		80	40	40	TX8B 40 40 L	Brass	MX8B 40 40 N	Nickel
		85	35	50	TX8B 35 50 L	Brass	MX8B 35 50 N	Nickel
		90	30	30	TX8BTB3030L	Brass	MX8BTB3030N	Nickel
		90	35	30	TX8BTB3530L	Brass	MX8BTB3530N	Nickel
European with assistant function		L	A	B	Cam = 15 mm	Finish	Cam = 15 mm	Finish
		60	30	30	TX85 30 30 LLIM	Brass	TX85 30 30 NLIM	Nickel
		70	30	40	TX85 30 40 LLIM	Brass	TX85 30 40 NLIM	Nickel
		70	35	35	TX85 35 35 LLIM	Brass	TX85 35 35 NLIM	Nickel
		80	40	40	TX85 40 40 LLIM	Brass	TX85 40 40 NLIM	Nickel
		90	40	50	TX85 40 50 LLIM	Brass	TX85 40 50 NLIM	Nickel
		90	45	45	TX85 45 45 LLIM	Brass	TX85 45 45 NLIM	Nickel



These cylinders are provided with 4 owner keys and one for the assistant. Both side A and B includes the function.

* To process "master keyed" and "key alike" orders add either AM or KA in each part number, respectively.

** The butler system lets operate with the key from the outside even if knob is blocked. Is a solution thought for schools, geriatrics.. etc.

D

High security cylinder TX80

Patented

European profile

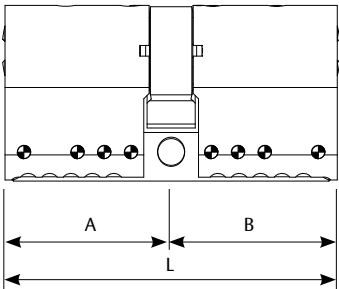
European modular				L	A	B	Exc. = 15 mm	Finish	Exc. = 15 mm	Finish
				140	--	--	TX855140LMD	Brass	TX855140NMD	Nickel
				145	--	--	TX855145LMD	Brass	TX855145NMD	Nickel
				150	--	--	TX855150LMD	Brass	TX855150NMD	Nickel
				155	--	--	TX855155LMD	Brass	TX855155NMD	Nickel
				160	--	--	TX855160LMD	Brass	TX855160NMD	Nickel
				165	--	--	TX855165LMD	Brass	TX855165NMD	Nickel
				170	--	--	TX855170LMD	Brass	TX855170NMD	Nickel
				175	--	--	TX855175LMD	Brass	TX855175NMD	Nickel
				180	--	--	TX855180LMD	Brass	TX855180NMD	Nickel
				185	--	--	TX855185LMD	Brass	TX855185NMD	Nickel
				190	--	--	TX855190LMD	Brass	TX855190NMD	Nickel
				195	--	--	TX855195LMD	Brass	TX855195NMD	Nickel
				200	--	--	TX855200LMD	Brass	TX855200NMD	Nickel

These part numbers are for modular cylinders assembled from the factory. Measurements for side A and B will be required when processing an order. The Cam, only if it is different to the standard (15 mm).

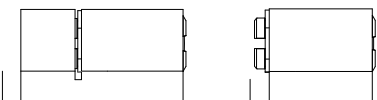
European modular heads (to be used with the modular cases)				L	A	B	-	Finish	-	Finish
				30	30	--	TX8530LMD	Brass	TX8530NMD	Níquel
				45	45	--	TX8545LMD	Brass	TX8545NMD	Níquel
				60	30	30	TX8560LMD	Brass	TX8560NMD	Níquel
				75	30	45	TX8575LMD	Brass	TX8575NMD	Níquel
				90	45	45	TX8590LMD	Brass	TX8590NMD	Níquel

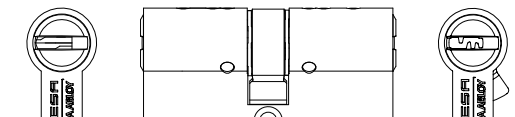
Stainless European with antidust				L	A Antidust	B Key	Cam = 15 mm	Finish	Cam = 15 mm	Finish
				60	30	30	TX8G3030L	Brass	TX8G3030N	Nickel
				70	30	40	TX8G3040L	Brass	TX8G3040N	Nickel
				70	35	35	TX8G3535L	Brass	TX8G3535N	Nickel
				75	40	40	TX8G4040L	Brass	TX8G4040N	Nickel
				80	35	45	TX8G3545L	Brass	TX8G3545N	Nickel
				80	40	40	TX8G4040L	Brass	TX8G4040N	Nickel

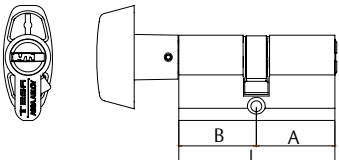
Stainless European with antidust				L	A Antidust	B Knob	Cam = 15 mm	Finish	Cam = 15 mm	Finish
				60	30	30	TX8G3030BL	Brass	TX8G3030BN	Nickel
				70	30	40	TX8G3040BL	Brass	TX8G3040BN	Nickel
				75	40	35	TX8G4035BL	Brass	TX8G4035BN	Nickel
				85	50	35	TX8G5035BL	Brass	TX8G5035BN	Nickel

* To process "master keyed" and "key alike" orders add either AM or KA in each part number, respectively.

High security cylinder TX80

Patented

European profile

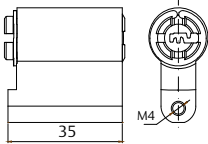
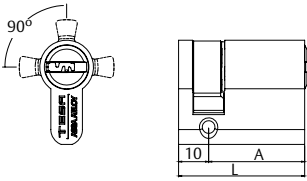
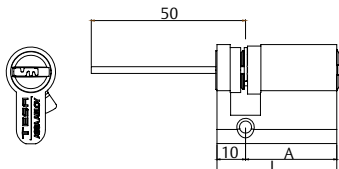
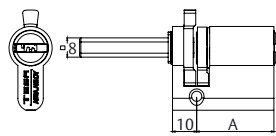
Padlock exchangeable		L	A	B	Product code	Finish
		-	-	-	TX85CL55L	Brass
		-	-	-	TX85CL55N	Nickel
Adjustable cam. Single profile (4 positions)		L	A	B	Product code	Finish
		40	30	10	TX8W3010L	Brass
		40	30	10	TX8W3010N	Nickel
Adjustable european cylinder		L	A	B	Product code	Finish
	40	30	10	TX8R3010L	Brass	
	40	30	10	TX8R3010N	Nickel	
	50	40	10	TX8R4010L	Brass	
	50	40	10	TX8R4010N	Nickel	
Euro cylinder for lock set 3520.		L	A	B	Product code	Finish
	40	30	10	TX82520L	Brass	
	40	30	10	TX82520N	Nickel	

* To process "master keyed" and "key alike" orders add either AM or KA in each part number, respectively.

D

High security cylinder TX80

Patented

Round profiles

Round for TS lock sets		Ø	Inside length	Outside length	Product code	Finish
Inside		28	30	45	TX8TS40LC	Brass
		28	30	45	TX8TS40LT	Brass
Outside						
The ref. LC includes external shield and fixing plate.						

Round for TS lock sets		Ø	Inside length	Outside length	Product code	Finish
Inside		28	30	Adjustable	TX8TSRFLC	Brass
		28	30	Adjustable	TX8TSRFLT	Brass
Outside						
The ref. LC includes external shield and fixing plate.						

Multifort Lock		Ø	Inside length	Outside length	Product code	Finish
NEW		28	31	Adjustable	TX8TSCOLC	Brass
		28	31	Adjustable	TX8TSCOL	Brass
The reference that ends with ...COLC includes the external escutcheon.						

Adjustable round cylinder		Ø	Inside length	Outside length	Product code	Finish
		28	-	Adjustable	55TX85LT	Brass
		28	-	Adjustable	55TX85LN	Nickel

* To process "master keyed" and "key alike" orders add either AM or KA in each part number, respectively.

High security cylinder TX80

Patented

Round profiles

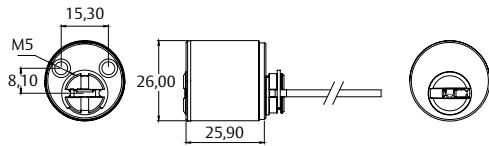

* Tubes to extend the length of the cylinder are sold apart
Part number with "H" = AUMON / Serraller = "V"

Round for AUMON & Serraller locks		Ø	Inside length	Outside length	Product code	Finish
		26	-	Adjustable	TX85REGAUHL	Brass
		26	-	Adjustable	TX85REGAUHN	Nickel
		26	-	Adjustable	TX85REGAUVL	Brass
		26	-	Adjustable	TX85REGAUVN	Nickel
Accessories	Lenght				Product code	Finish
TUBE	22				TUB2526L22L	Brass
TUBE	22				TUB2526L22N	Nickel

High security cylinder TX80

Patented

Round profiles

682		Metric	Type	Function	Product code	Finish
		23	Mechanic	-	682M23SE5NM	Nickel
		23	Mechanic	Withdrawal 2 positions	682M23TX802P	Nickel
		23	Electric	1 switch & return	682M23SE5CR	Nickel
		27	Mechanic	-	682TX8NM	Nickel
		27	Electric	1 micro switch	682TX81C	Nickel
		27	Electric	1 switch & return	682TX8CR	Nickel
		27	Electric	2 micro switches	682TX82C	Nickel

* To process "master keyed" and "key alike" orders add either AM or KA in each part number, respectively.

High security cylinder TK100



Technical data

TK100 cylinders have been designed with the most exclusive protection systems. This newly version integrates, in addition of the patent, an exclusive orbit combination system which fully surpasses the maximum key security grade specified in the standard regulation. In addition to that, this new manufacturing concept improves against non-destructive opening methods such as bumping, picking...etc. To complete the maximum security grade in all its extension, this model incorporates extra protections to resist the most usual attacks applied when breaking in.

In terms of drill protections, TK100, in addition of incorporating hardened pins, includes a new protector shield integrated. With this new cylinder, TESA starts a new gait which leads the future in all the cylinder range.

Features

- » Type of key: Flat, non-duplicable and patented.
- » Number of rows : 2
- » Number of pins: 10 + 2 security sensors in the key.
- » Technology: DROP ORBITAL (TESA Exclusive)
- » Combinatory: It reaches way above the degree 6 of the standard.
- » Masterkey systems: Superior capacity with no need to use passive pins.
- » Resistance to corrosion and temperature: Degree C
- » Advanced antibump.
- » Top antipick protection.
- » Antipick protection way above the maximum degree specified by the European standard.
- » Antiextraction rotor.
- » Corona pins on rotor front.
- » The bridge of the body features preinstalled reinforced steel.
- » Resistance: 200,000 cycles.
- » Preinstalled double-security clutch.
- » 5 narrow-neck keys per cylinder.
- » New, ergonomic key design.
- » Key duplication and cylinders are protected via ownership card.
- » Certified according to the EN 1303 standard.

Options

- » Finishes: Brass / Nickel.
- » Cam: DIN R15 and R13.
- » Formats available: Key different, master keyed, key alike and specific codes.
- » A wide range of sizes and profiles.
- » Colour points to differentiate master key levels.

Master key systems

The new orbit permutation system TESA has patented gives TK100 the highest level of security ever seen in the market. For that reason, TK100 is the ideal system for master keyed requirements. It does not matter how complex the master keying is. TK100 will solve, widely, every type of lock charts.

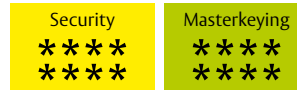

European standard regulation

TK100 widely surpasses the different laboratory tests specified in the standard European regulation.

1	6	0	1	0	C	6	2
Key resistance (Grade 0-1)	Lifespan (Grade 4-6)	Door mass (Not applied in cylinder)	Fire resistance (Grade 0-1)	Safety of the people (Not applied in cylinders)	Corrosion and temperature resistance (Grade 0-A-B-C)	Key related security (Grade 1 to 6)	Attack resistance (Grade 0 to 2)

Recommendations.

- » Use TESA lubricant to lengthen the maximum lifespan of the cylinder.
- » TESA recommends to the user of the TK100 to keep the property card in a safe and secure location. Only by presenting this card, can one obtain key and cylinder copies.
- » For safety reasons, when you install a new cylinder, remember that once installed, it should not project more than 1mm.







High security cylinder TK100

Patented

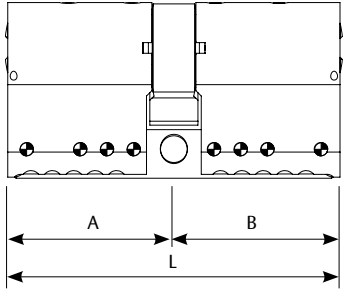
European profile

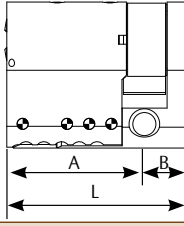

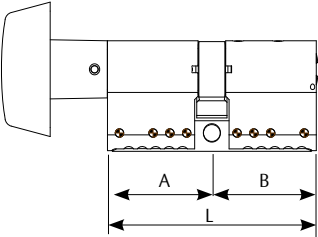
Double european		L	A	B	Cam = 15 mm	Finish	Short cam Cam = 13,2 mm	Finish
		60	30	30	TK15 30 30 L	Brass	MK15 30 30 N	Nickel
		65	30	35	TK15 30 35 L	Brass	MK15 30 35 N	Nickel
		70	30	40	TK15 30 40 L	Brass	MK15 30 40 N	Nickel
		70	35	35	TK15 35 35 L	Brass	MK15 35 35 N	Nickel
		75	30	45	TK15 30 45 L	Brass	MK15 30 45 N	Nickel
		75	35	40	TK15 35 40 L	Brass	MK15 35 40 N	Nickel
		80	30	50	TK15 30 50 L	Brass	MK15 30 50 N	Nickel
		80	35	45	TK15 35 45 L	Brass	MK15 35 45 N	Nickel
		80	40	40	TK15 40 40 L	Brass	MK15 40 40 N	Nickel
		85	35	50	TK15 35 50 L	Brass	MK15 35 50 N	Nickel
		90	30	60	TK15 30 60 L	Brass	MK15 30 60 N	Nickel
		90	35	55	TK15 35 55 L	Brass	MK15 35 55 N	Nickel
		90	40	50	TK15 40 50 L	Brass	MK15 40 50 N	Nickel
		90	45	45	TK15 45 45 L	Brass	MK15 45 45 N	Nickel
		100	30	70	TK15 30 70 L	Brass	MK15 30 70 N	Nickel
		100	40	60	TK15 40 60 L	Brass	MK15 40 60 N	Nickel
		100	50	50	TK15 50 50 L	Brass	MK15 50 50 N	Nickel
		110	30	80	TK15 30 80 L	Brass	MK15 30 80 N	Nickel
		110	50	60	TK15 50 60 L	Brass	MK15 50 60 N	Nickel
		120	30	90	TK15 30 90 L	Brass	MK15 30 90 N	Nickel
		120	40	80	TK15 40 80 L	Brass	MK15 40 80 N	Nickel
		120	60	60	TK15 60 60 L	Brass	MK15 60 60 N	Nickel
		130	30	100	TK15 31 00 L	Brass	MK15 31 00 N	Nickel
		140	40	100	TK15 41 00 L	Brass	MK15 41 00 N	Nickel
		150	50	100	TK15 51 00 L	Brass	MK15 51 00 N	Nickel
		160	60	100	TK15 61 00 L	Brass	MK15 61 00 N	Nickel
Single european. (8 positions standard)		L	A	B	Cam = 15 mm	Finish	Cam = 13,2 mm	Finish
		40	30	10	TK15 30 10 L	Brass	MK15 30 10 N	Nickel
		45	35	10	TK15 35 10 L	Brass	MK15 35 10 N	Nickel
		50	40	10	TK15 40 10 L	Brass	MK15 40 10 N	Nickel
		60	50	10	TK15 50 10 L	Brass	MK15 50 10 N	Nickel
		70	60	10	TK15 60 10 L	Brass	MK15 60 10 N	Nickel
		80	70	10	TK15 70 10 L	Brass	MK15 70 10 N	Nickel
		90	80	10	TK15 80 10 L	Brass	MK15 80 10 N	Nickel
		100	90	10	TK15 90 10 L	Brass	MK15 90 10 N	Nickel
Knob european.		L	A	B	Cam = 15 mm	Finish	Cam = 13,2 mm	Finish
		60	30	30	TK1B 30 30 L	Brass	MK1B 30 30 N	Nickel
		65	30	35	TK1B 30 35 L	Brass	MK1B 30 35 N	Nickel
		70	35	35	TK1B 35 35 L	Brass	MK1B 35 35 N	Nickel
		70	40	30	TK1B 40 30 L	Brass	MK1B 40 30 N	Nickel
		80	30	50	TK1B 30 50 L	Brass	MK1B 30 50 N	Nickel
		80	40	40	TK1B 40 40 L	Brass	MK1B 40 40 N	Nickel
		85	35	50	TK1B 35 50 L	Brass	MK1B 35 50 N	Nickel
		90	30	30	TK1BTB3030L	Brass	MK1BTB3030N	Nickel
		90	35	30	TK1BTB3530L	Brass	MK1BTB3530N	Nickel

* To process "master keyed" and "key alike" orders add either AM or KA in each part number, respectively.

** The butler system lets operate with the key form the outside even if knob is blocked from the inside. Is a solution thought for schools, geriatrics.etc.

High security cylinder TK100

Patented

European profile

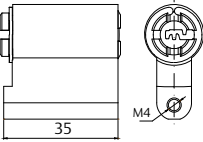
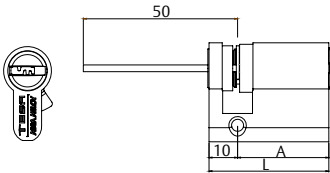
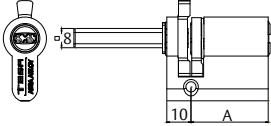
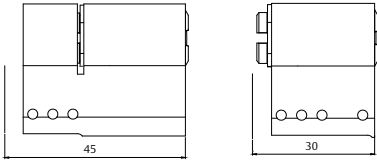
Padlock exchangeable		L	A	B	Product code	Finish		
		-	-	-	TK15CL55L	Brass		
		-	-	-	TK15CL55N	Nickel		
Adjustable european cylinder		L	A	B	Product code	Finish		
	40	30	10	TK1R3010L	Brass			
	40	30	10	TK1R3010N	Nickel			
	50	40	10	TK1R4010L	Brass			
	50	40	10	TK1R4010N	Nickel			
Euro cylinder for lock set 3520		L	A	B	Product code	Finish		
	40	30	10	TK12520L	Brass			
	40	30	10	TK12520N	Nickel			
European modular heads (to be used with the modular cases)		L	A	B	Product code	Finish	Product code	Finish
	30	30	--	TK1530LMD	Brass	TK1530NMD	Nickel	
	45	45	--	TK1545LMD	Brass	TK1545NMD	Nickel	
	60	30	30	TK1560LMD	Brass	TK1560NMD	Nickel	
	75	30	45	TK1575LMD	Brass	TK1575NMD	Nickel	
	90	45	45	TK1590LMD	Brass	TK1590NMD	Nickel	

* To process "master keyed" and "key alike" orders add either AM or KA in each part number, respectively.

D

High security cylinder TK100

Patented

Round profiles

Round for TS lock sets		Ø	Inside length	Outside length	Product code	Finish
Inside		28	30	45	TK1TS40LC	Brass
		28	30	45	TK1TS40LT	Brass
Outside						

The ref. LC includes external shield and fixing plate.

Round for TS lock sets		Ø	Inside length	Outside length	Product code	Finish
Inside		28	30	Adjustable	TK1TSRFLC	Brass
		28	30	Adjustable	TK1TSRFLT	Brass
Outside						

The ref. LC includes external shield and fixing plate.

Multifort lock		Ø	Inside length	Outside length	Product code	Finish
		28	31	Adjustable	TK1TSCOLC	Brass
		28	31	Adjustable	TK1TSCOL	Nickel

The ref. LC includes external shield and fixing plate.

Adjustable round cylinder		Ø	Inside length	Outside length	Product code	Finish
		28	-	Adjustable	55TK15LT	Brass
		28	-	Adjustable	55TK15LN	Nickel

* To process "master keyed" and "key alike" orders add either AM or KA in each part number, respectively.

High security cylinder TK100

Patented

Round profiles

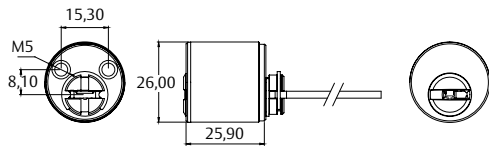

* Tubes to extend the length of the cylinder are sold apart
Part number with "H" = AUMON / Serraller = "V"

Round for AUMON & Serraller locks		Ø	Inside length	Outside length	Product code	Finish
		26	-	Adjustable	TK15REGAUHL	Brass
		26	-	Adjustable	TK15REGAUHN	Nickel
		26	-	Adjustable	TK15REGAUVL	Brass
		26	-	Adjustable	TK15REGAUVN	Nickel
Accesories	Lenght			Product code	Finish	
TUBE	22			TUB2526L22L	Brass	
TUBE	22			TUB2526L22N	Nickel	

High security cylinder TK100

Patented

Round profiles

682		Metric	Type	Function	Product code	Finish
		23	Mechanic	-	682M23TK1NM	Nickel
		23	Electric	1 switch & return	682M23TK1CR	Nickel
		27	Mechanic	-	682TK1NM	Nickel
		27	Electric	1 micro switch	682TK11C	Nickel
		27	Electric	1 switch & return	682TK1CR	Nickel
		27	Electric	2 micro switches	682TK12C	Nickel

* To process "master keyed" and "key alike" orders add either AM or KA in each part number, respectively.

Master key systems



Master key systems

A master key system is a planned locking system where a master key can open more than one cylinder, even if each cylinder has its own key. For offices, residential homes and blocks of various floors, the master key system is the immediate solution that allows to establish an access control while reducing the number of keys that must be handled: security and comfort.

Central locking system.
(Community type)

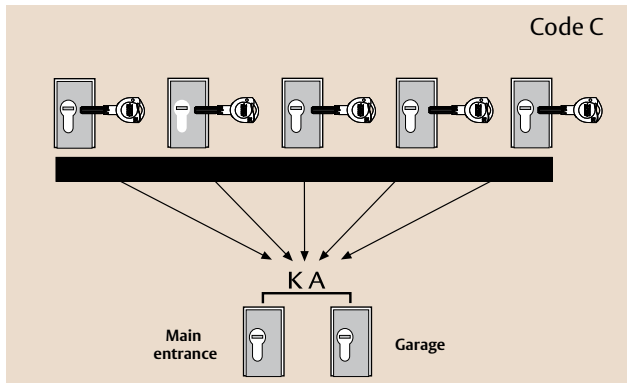

Central locking system with master key.
(Company type)

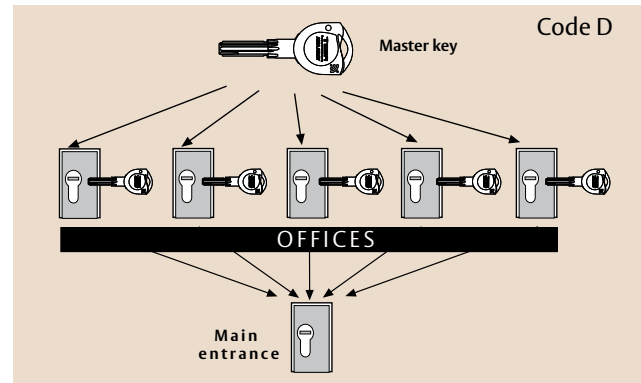

Central locking with several levels.
(Apartment blocks type)

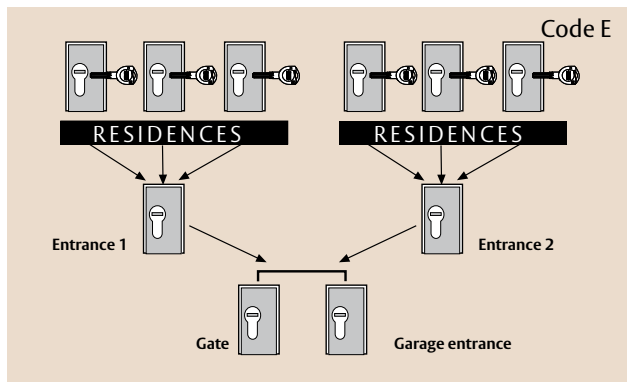

Simple master key suite.

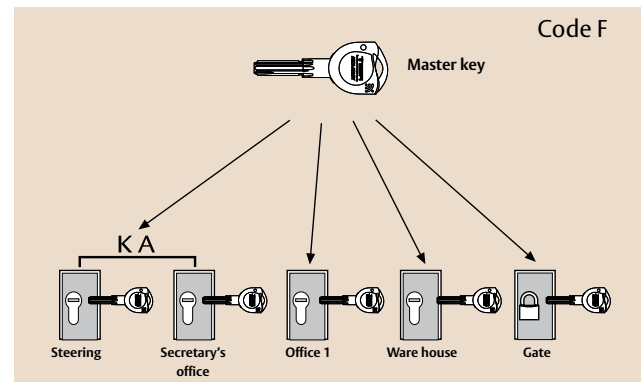

Group master key suite.
(Hotel type)

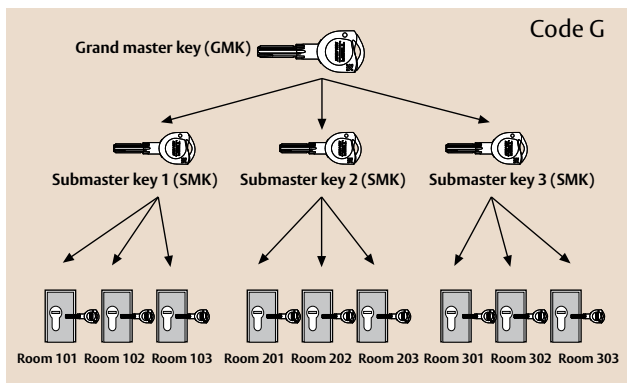

Complex master key system
(Company type)

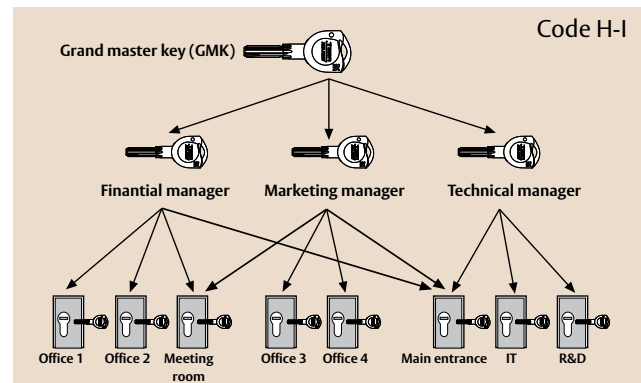

How can I order a masterkeying?

1. Masterkeying partnumbers for each cylinder

TESA allows you to use its masterkeying service, regardless of the cylinder model you have chosen. Add to the reference of the spare cylinder: KA, for key alike, or add to a key number, and AM for the rest of the Masterkey systems.

Example KEY ALIKE:

Example Masterkey systems:

TX853030NKA

TX853030NAM

2. A surcharge is added depending on the type of masterkey system

Product code			
Type	System	Code	Code description
		A	Copies of the same key
	TE5	B	To a key number
	TD5	C	Simple entrance door masterkeying
	T60	D	Entrance door masterkeying with master key
REC1	TD60	E	Entrance door masterkeying with shared keys
REC124 (24h.)	T80	F	Simple masterkeying
REC148 (48h.)	TX8	G	Masterkeying by groups - top master and submasters
	TK6	H	Simple crosswise masterkeying
	TK1	I	More complex: please ask
		K	Construction key

See description of types of masterkeying on the previous page

Example of masterkeying of TK100 cylinder for copies of the same key: REC1TK

Note; Simple Masterkey systems, of groups or entrance doors with more than 200 different key features, they may be invoiced with the H or I surcharge. It will depend on the number of features and the system chosen for the masterkeying.

Discount due to one less key

Product code	Description	Notes
LLAMENTE5	Discount one less key TE5	Only after 100 units
LLAMENTD5	Discount one less key TD5	-
LLAMENT60	Discount one less key T60	-
LLAMENTD60	Discount one less key TD60	-
LLAMENT70	Discount one less key T70	-
LLAMENT80	Discount one less key T80	-
LLAMENTX80	Discount one less key TX80	-
LLAMENTK6	Discount one less key TK6	-
LLAMENT10	Discount one less key T10	-
LLAMENTK100	Discount one less key TK100	-

Marking of keys and cylinders

Product code	Description
MARCARLLA	Special marking of keys
MARCARCIL	Marking of cylinders

MARCARCIL Maximum 8 alphanumeric characters per cylinder or key.

Supplementary keys

System	Material	Supplementary key
Borja	Steel	LLAVSUBJ
TE5	Steel	LLAVSUAH
TE5	Nickel-plated brass	LLAVSUAL
TD5	Nickel-plated brass	LLAVSUTD5
T60	Nickel-plated brass	LLAVSUT60
TD60	Nickel-plated brass	LLAVSUTD60
T70	Nickel-plated brass	LLAVSUT70
T80	Nickel silver	LLAVSUT80
TX80	Nickel silver	LLAVSUTX8
TK6	Nickel silver	LLAVSUTK6ALP
T10	Nickel silver	LLAVSUT10
TK100	Nickel silver	LLAVSUTK100

Master key systems

TESA WIZARD. Express Masterkey Systems

Service ONLINE MASTERKEYING SERVICE

TESA's 24-hour service delivers the masterkeying to the shipping company in 24 hours (calculated in working days (TESA Irún's calendar) from the moment the order accepted by TESA is taken. All orders processed via this service will be free of charge. The system is based on the TESA WIZARD platform for the introduction of online orders. (In order to register, please contact TESA).



NEW
NOW ALSO in
TD5 - TD60 - TX80

Requirements:

1. Maximum: 100 cylinders per order. In case of bigger amounts, it will not be possible to 'split' the amount in several orders.
2. All customers making online orders before 5 pm are guaranteed to receive the order the following (working) day. In case of exceptional causes, a message will be sent to VoBo customer.
3. 24-hour orders may not be cancelled.
4. The customer must register as a TESA WIZARD user. Every customer will have an ID as well as an user code and a password.

RANGE

Sawn key (TE5-TE6-TD5)

Double cylinder or knob-cylinder:

- » From 30x30 to 50x50 with 5-mm increases to R15 cam in BRASS-plated and NICKEL-plated finishes
- » Sizes 30x30 - 35x35 - 30x40 - 40x40 - 30x50 with cam R13 (Finish only in NICKEL)

Half cylinder:

- » From 30x10 - 35x10 - 40x10 - 50x10 and 30R x 10 (Adjustable) with R15 cam in BRASS-plated and NICKEL-plated finishes.
- » 30x10 sizes with R13 cam and finish only in NICKEL.

Dimple key (T60-TD60-T80-TX80):

Double cylinder or knob-cylinder:

- » From 30X30 to 40X40 with 5-mm increases with R15 cam and BRASS-plated and NICKEL-plated finishes.
- » Sizes 30x30 - 35x35 - 30x40 - 40x40 - 30x50 with R13 cam (Finish only in NICKEL)-

Half cylinder:

- » Sizes 30x10 - 35x10 - 40x10 with R15 cam and BRASS-plated and NICKEL-plated finishes.
- » 30x10 size with R13 cam and finish only in NICKEL.

682 cylinder:

- » M23 and M27 (+48h extra).
- » Electric and mechanical activation.
- » NICKEL-plated finish.

		Product code		Description
Type	System	Code		
REC124	TE5	A		Copies of the same key
	TD5	B		To a key number
	TE6	C		Simple masterkeying for entrance door
	T60	D		Entrance door masterkeying with master key
	TD60	E		Entrance door masterkeying with shared keys
	T80	F		Simple masterkeying
	TX80	G		Masterkeying by groups - top master and submasters

Note: Cam 13,2 mm (for metal keys) valid in TE5, T60 and T80 system sizes 30x30, 30x40, 35x35, 30x10, 30x50, 40x40, 30B30 (only LN).

In case the order includes any cylinder not specified in the range (due to the amount, a special reference or a complexity issue), you must consult the factory about the new deadline.

Master key systems



TESA WIZARD. Express Service of Key Copies

TESA's 24-hour service also includes the ONLINE service of key copies, delivered to the shipping company in 24 hours calculated in working days (TESA Irún's calendar). Key copies via TESA WIZARD are available in the following systems and formats:

FORMATS

- » Copies of KD and KA keys.
- » Copies of keys with AM cylinders (both calculated in TESA WIZARD as outside of WIZARD)

SYSTEMS

- » TE5 » TD60 » TX80 (Both V2 and VD)
- » TD5 » T70
- » TE6 (Keyway KT1) » T80 » TK100
- » T60 » TK6 (Keyway K1D)

HOURS/SERVICE

TESA sends orders with a 24-HOUR SERVICE (Available materials in the warehouse) as long as the orders have been made before 5 pm. From that moment on, 24 hours are added.

ORDERS/LINES/SHIPPING COSTS

TESA recommends you to bring together the maximum number of key copies in one single order, generating one single shipping and, consequently, one single shipping charge.

You may order copies of different key references in one single order.

The software generates ONE SHIPPING CHARGE PER ORDER.

It is not possible to GROUP SEVERAL ORDERS UNDER ONE SHIPPING CHARGE, but TESA WIZARD provides the option of including all lines of copies in one single order by using the DRAFT option.



TESA **48** HOURS

With this service, your orders will be manufactured in 48 hours. Always according to TESA's calendar and considering that has been processed within the range specified latter on. In addition, the order has to specify the term "express 48h delivery".



Working conditions:

1. Maximum order quantity: 100 units
2. Daily time limit: 11.00 am GMT 1:00. Orders received later will be postponed one day.
3. 48 hour orders can not be cancelled.
4. The orders must be specified in a lock chart made on excel or similar application.

RANGE

Serrated key (TE5-TE6-TD5)

Double cylinder or knob-cylinder:

- » From 30x30 to 50x50 with 5-mm increases to R15 cam in BRASS-plated and NICKEL-plated finishes
- » Sizes 30x30 - 35x35 - 30x40 - 40x40 - 30x50 with cam R13 (Finish only in NICKEL)

Half cylinder:

- » From 30x10 - 35x10 - 40x10 - 50x10 and 30R x 10 (Adjustable) with R15 cam in BRASS-plated and NICKEL-plated finishes.
- » 30x10 sizes with R13 cam and finish only in NICKEL.

Flat key (T60-TD60-T80-TX80):

Double cylinder or knob-cylinder:

- » From 30X30 to 40X40 with 5-mm increases with R15 cam and BRASS-plated and NICKEL-plated finishes.
- » Sizes 30x30 - 35x35 - 30x40 - 40x40 - 30x50 with R13 cam (Finish only in NICKEL)-

Half cylinder:

- » Sizes 30x10 - 35x10 - 40x10 with R15 cam and BRASS-plated and NICKEL-plated finishes.
- » 30x10 size with R13 cam and finish only in NICKEL.

682 cylinder:

- » M23 and M27 (+48h extra).
- » Electric and mechanical activation.
- » NICKEL-plated finish.

Product code			Description
Type	System	Code	
REC148	TE5	A	Copies of the same key
	TD5	B	To a key number
	T60	C	Simple masterkeying for entrance door
	TD60	D	Entrance door masterkeying with master key
	T80	E	Entrance door masterkeying with shared keys
	TX80	F	Simple masterkeying
			G

Note: Cam 13,2 mm (for metal keys) valid in TE5, T60 and T80 system sizes 30x30, 30x40, 35x35, 30x10, 30x50, 40x40, 30B30 (only LN).

In case the order includes any cylinder not specified in the range (due to the amount, a special reference or a complexity issue), you must consult the factory about the new deadline.

Accessories and cylinder parts

Key blanks

System	Material	Product code
TE5	Steel	LLAVTE5HH
TE5	Brass nickel plated	LLAVTE5LT
T60	Brass nickel plated	LLAVBRT60NS
T80	Nickel silver	LLAVBRT80

Keys copies

System	Material	Cut key part
Borja	Steel	LLAVD2 1D, 1I, 2D, 2I, 3D, 3I, 4D, 4I, 5D, 5I
TE5	Steel	LLAVD3HH
TE5	Brass nickel plated	LLAVD3LT
TD5	Brass nickel plated	LLARTD5
T60	Brass nickel plated	LLART60
TD60	Brass nickel plated	LLARTD60
T70	Brass nickel plated	LLART70
T80	Nickel silver	LLART80
TK6	Nickel silver	LLARTK6ALP
TX80	Nickel silver	LLARTX80
T10	Nickel silver	LLART10
T12	Nickel silver	LLART12
TK100	Nickel silver	LLARTK100



Combi RFID keys

The RFID COMBI key from TESA allows mechanical master key systems to be compatible with TESA Standalone or other access control systems in only one device or credential.

COMBI key can be compatible with mechanical T80, TX80 or TK100 cylinders, furthermore, user will also have access to RFID MIFARE technology electronic lock or wall readers simply approaching the key head.

System	Product code (cut key)	Product code (blank key)
T80	LLAT80TALLCOMBI	LLAVBRT80COMBI
TX80	LLATX8TALLCOMBI	
TK100	LLATK1TALLCOMBI	



Colour points for keys

Colour	Reference*	Suitable for keys:
Black	PINLLAVENE	
Green	PINLLAVEVE	TX80 new image
Yellow	PINLLAVEAM	TK100 v2
Red	PINLLAVERO	TK6
Purple	PINLLAVEMO	



* Sold in 100-unit bags.

Accessories and cylinder parts

Modularity

Modular cases.

Both cases and the primary modules will let you assemble every measurement and format (double cylinder, single and thumb turn) in a very short time. Moreover, with this version and thanks to the union bars, these assemblies strengthen the snap resistance.





Modular KIT

Product code	Components included	Qty.	Components included	Qty.
KITMODULARTESA	Sloted modular body extension of 5mm	4	Modular bar of 1+5 holes.	2
	Sloted modular body extension of 10mm	4	Modular bar of 1+6 holes.	2
	Modular body extension of 15mm.	4	Modular bar of 1+7 holes.	2
	Modular body extension of 20mm.	4	Modular bar of 3+3 holes.	3
	Sloted modular body extension of 30mm.	4	Modular bar of 3+4 holes.	3
	Modular body extension of 30mm.	4	Modular bar of 3+5 holes.	3
	Modular body extension of 60mm.	2	Modular bar of 3+6 holes.	3
	Modular body extension for single cylinders	5	Modular bar of 3+7 holes.	3
	Rotor extension for side 35-5mm	4	Modular bar of 4+4 holes.	3
	Rotor extension for side 40-10mm	4	Modular bar of 4+5 holes.	3
	Rotor extension for side 45-15mm	4	Modular bar of 4+6 holes.	3
	Rotor extension for side 50-20mm	4	Modular bar of 4+7 holes.	3
	Rotor extension for side 60-30mm	4	Modular bar of 5+5 holes.	3
	Rotor extension for side 65-35mm	4	Modular bar of 5+6 holes.	3
	Rotor extension for side 70-40mm	4	Modular bar of 5+7 holes.	3
	Rotor extension for side 80-50mm	4	Modular bar of 6+7 holes.	3
	Clutch DS extension for side 40. (10mm)	10	Modular bar of 6+6 holes.	3
	Clutch DS extension for side 45. (15mm)	10	Modular bar of 7+7 holes.	3
	Clutch DS extension for side 50. (20mm)	10	Extension bar of 30mm	3
	Clutch DS extension for side 60. (30mm)	5	Extension bar of 40mm	3
Clutch DS extension for side 70. (40mm)	5	Extension bar of 50mm	3	
Clutch DS extension for side 80. (50mm)	5	Extension bar of 10mm	3	
Clutch STD extension for side 50. (20mm)	5	Union pins of Ø2.5x9.8mm	100	
Clutch STD extension for side 35. (5mm)	5	Self clumping retainners	100	
Clutch STD extension for side 40. (10mm)	5	Assembling bed.	1	
	Modular bar of 1+3 holes.	2	Punch to remove the union pins. Ø2x70mm	1
	Modular bar of 1+4 holes.	2	Punch to rivet the cylinder. Ø6x70mm	1

Product code	Components included	Qty.	Components included	Qty.
KITCOMPONENTES	Cams DIN R15 25°	50	Spindle knob of brass for knob side 27/37mm.	5
	Cams R13 0° for narrow styles.	50	Spindle knob of brass for knob side 40/60mm.	5
	Self clamping clips	100	Spindle knob of brass for knob side 65/85mm.	5
	Adjustable retaining clips	100	Spindle knob of brass for knob side 90/110mm.	5
	Standard clutches 30x30mm	25	Knob of polished brass.	5
	Double security clutches 30x30mm	25	Knob nickel plated.	5
	Double security clutches 30x35mm	25	Pins DIN 7343 Ø2x16mm	100
	Double security clutches 35x35mm	25	Fixing screw M5x80mm of brass.	25
	Knob clutch for key side 30mm (Dimple cylinder lock)	25	Fixing screw M5x80mm nickel plated.	25
	Knob clutch for key side 35mm.	25	Cams DIN R15 for single cylinders	25
	Knob clutch for key side 30mm (Saw cylinder lock)	25	Cams R13 for single cylinders	25



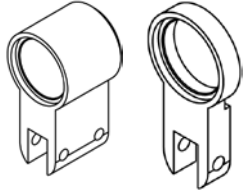
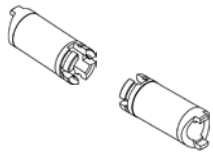
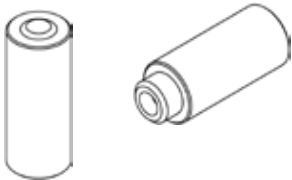
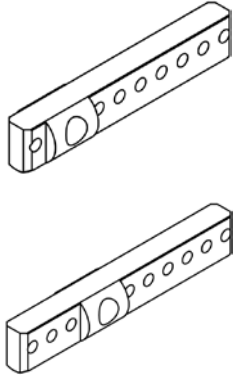
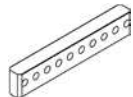









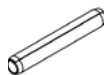

Accessories and cylinder parts

Replacement parts for KITMODULARTESA

Modular KIT	Product code	Description	
	MDSUPLE05R	10 Sloted modular body extension of 5mm	
	MDSUPLE10R	10 Sloted modular body extension of 10mm	
	MDSUPLE15N	10 Modular body extension of 15mm.	
	MDSUPLE20N	10 Modular body extension of 20mm.	
	MDSUPLE30R	10 Sloted modular body extension of 30mm.	
	MDSUPLE60N	10 Modular body extension of 30mm.	
	MDSUPLE00N	5 Modular body extension of 60mm.	
	MDCNO30LMB	10 Modular body extension for single cylinders brass	
	MDCNO30NM	10 Modular body extension for single cylinders nickel	
		SUPLEXTST3505	10 Rotor extension for side 35-5mm
SUPLEXTST4010		10 Rotor extension for side 40-10mm	
SUPLEXTST4515		10 Rotor extension for side 45-15mm	
SUPLEXTST5020		10 Rotor extension for side 50-20mm	
SUPLEXTST6030		10 Rotor extension for side 60-30mm	
SUPLEXTST6535		10 Rotor extension for side 65-35mm	
SUPLEXTST7040		10 Rotor extension for side 70-40mm	
SUPLEXTST8050		10 Rotor extension for side 80-50mm	
		SUPLINTE40DS	10 Clutch DS extension for side 40. (10mm)
		SUPLINTE45DS	10 Clutch DS extension for side 45. (15mm)
	SUPLINTE50DS	10 Clutch DS extension for side 50. (20mm)	
	SUPLINTE60DS	10 Clutch DS extension for side 60. (30mm)	
	SUPLINTE70DS	10 Clutch DS extension for side 70. (40mm)	
	SUPLINTE80DS	10 Clutch DS extension for side 80. (50mm)	
	SUPLINTE35	10 Clutch STD extension for side 50. (20mm)	
	SUPLINTE40	10 Clutch STD extension for side 35. (5mm)	
	SUPLINTE50	10 Clutch STD extension for side 40. (10mm)	
		MDBARRA13	10 Modular bar of 1+3 holes.
MDBARRA14		10 Modular bar of 1+4 holes.	
MDBARRA15		10 Modular bar of 1+5 holes.	
MDBARRA16		10 Modular bar of 1+6 holes.	
MDBARRA17		10 Modular bar of 1+7 holes.	
MDBARRA33		10 Modular bar of 3+3 holes.	
MDBARRA34		10 Modular bar of 3+4 holes.	
MDBARRA35		10 Modular bar of 3+5 holes.	
MDBARRA36		10 Modular bar of 3+6 holes.	
MDBARRA37		10 Modular bar of 3+7 holes.	
MDBARRA44		10 Modular bar of 4+4 holes.	
MDBARRA45		10 Modular bar of 4+5 holes.	
MDBARRA46		10 Modular bar of 4+6 holes.	
MDBARRA47		10 Modular bar of 4+7 holes.	
MDBARRA55		10 Modular bar of 5+5 holes.	
MDBARRA56		10 Modular bar of 5+6 holes.	
MDBARRA57		10 Modular bar of 5+7 holes.	
MDBARRA67		10 Modular bar of 6+7 holes.	
MDBARRA66	10 Modular bar of 6+6 holes.		
	MDALARG10	10 Extension bar of 10mm	
	MDALARG30	10 Extension bar of 30mm	
	MDALARG40	10 Extension bar of 40mm	
	MDALARG50	10 Extension bar of 50mm	
	MDPASADN	500 Punch to rivet the cylinder. Ø6x70mm	

Accessories and cylinder parts

Replacement parts for KITCOMPONENTES

	Product code	Description
	EXCR13D0	Cams R13 0° for narrow styles.
	EXCR15D5	Cams DIN R15 25°
	EXCR15M5	Cams DIN R15 for single cylinders
	EXCR13M0	Cams R13 for single cylinders
	EJEBOT2735	Spindle knob of brass for knob side 27/37mm.
	EJEBOT4060	Spindle knob of brass for knob side 40/60mm.
	EJEBOT6585	Spindle knob of brass for knob side 65/85mm.
	EJEBOT90110	Spindle knob of brass for knob side 90/110mm.
	PASADOR73432X16	Pins DIN 7343 Ø2x16mm
	MUELEJBOT	Thumb turn clutch spring.
	EMBRABOTT80	Knob clutch for key side 30mm (Dimple cylinder lock)
	EMBRABOT35	Knob clutch for key side 35mm.
	EMBRABOTIPS30	Knob clutch for key side 30mm (Sawn cylinder lock)
	BOTONELIPNM	Knob nickel plated.
	BOTONELIPAE	Knob of polished brass.
	EMBRAG3030	Standard clutches 30x30mm
	EMBRAGUEDS	Double security clutches 30x30mm
	EMBRADS3035	Double security clutches 30x35mm
	EMBRADS3535	Double security clutches 35x35mm
	TORN580HN	Fixing screw M5x80mm nickel plated.
	CLIEURO	Adjustable retaining clips
	ARANREP1	Self clamping clips

* Minimum order quantity: 50 Units.







** TK100 needs special components which are shown on the next page. They are not included in the "KITCOMPONENTES"

D

Accessories and cylinder parts

Modularity

Special parts for TK100

	Product code	Description
	MDTAPATK100	Body caps for TK100 Version 1.
	EMBRAGUETK100	Double security clutch 30x30mm
	EMBRAGUETK3035	Double security clutch 30x35mm
	EMBRAGUETK3535	Double security clutch 35x35mm
	EMBRABOTTK1	Knob clutch for key side of 30mm
	EMBRABOTTK35	Knob clutch for key side of 35mm

* Minimum order quantity: 50 units.

** These components are not included in the case "KITCOMPONENTES".

Pinion gears

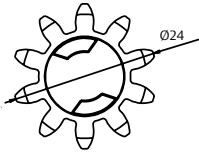
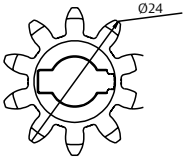
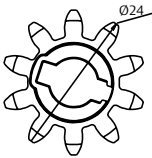
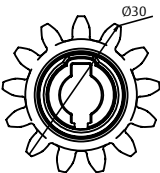
	Product code	Description
	EXCZ10D24	50 pinion gears with 10 teeth. Outside diameter is 24 mm and thickness, 8mm. Compatible with gears from both tooth and bottom land.
	EXCZ10D24V	50 pinion gears with 10 teeth. Outside diameter is 24 mm and thickness, 8mm. Compatible with gears from the bottom land.
	EXCZ10D24D	50 pinion gears with 10 teeth. Outside diameter is 24 mm and thickness, 8mm. Compatible with gears from the tooth.
	EXCZ13D30KSO	50 pinion gears with 13 teeth. Outside diameter is 30 mm and thickness, 4mm. Compatible with gears from the bottom land.

Accessories and cylinder parts

Key-contact electric cases

The electric cases activate an electric circuit by means of a key.

Mechanical features

- » Protection degree: IP 54
- » Requires a 30x10 cylinder of 8 positions with the cam located 90° to the left. (25° cam for the model: interlocking with key extraction)
- » Sizes:
Aluminium box: 75 x 75 x 52mm.
Front (mortise model): 100 x 125mm.

Electric features

- » Microswitch: Maximum voltage 220Vac Maximum intensity 5A
- » Led Maximum Voltage 12Vac

Available models of:

- » Rim or mortise
- » 2 or 3 positions
- » LED indicator option

Features

The multifunction microswitch allows the user to establish the right option for each application. One single model can operate with return function or interlocking.

Applications

- » **Return:** In applications where the activation of the microswitch puts the electric circuit into service. Example: garage doors. Once the key rotates, it activates the microswitch and later a spring enables the return for the extraction of the key.
- » **Interlocking:** For applications where it is convenient to have the key secured during the operation of the electric circuit. Example: In a hotel room, as an energy disconnecter. When the key rotates, it remains secured and activates the microswitch.

Models with interlocking are suitable for two different applications by merely switching the cam's position.

1. Cam 90° to the left (9 hours): when the key rotates, the circuit is closed. In order to remove the key, it must return to the original position and the circuit will remain open. In order to close the circuit, the key must be inside the box.
2. Cam to 25°: It allows the user to leave the circuit connected or disconnected by removing the key.

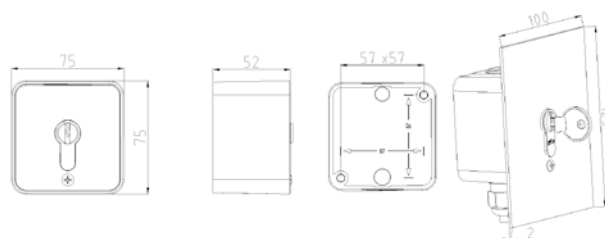

Model	Positions	LED	Mounting
CEL1ME	2	No	Mortise
CEL1MS	2	No	Rim
CEL1LE	2	No	Mortise
CEL1LS	2	No	Rim
CEL2ME	3	Si	Mortise
CEL2MS	3	Si	Rim
CEL2LE	3	Si	Mortise
CEL2LS	3	Si	Rim

Cylinder for electric case with adjustable cam

- » These cases require a 30 x 10 cylinder and a cam 90° to the left (9 hours).
- » Except for the 1ME model with closed / open micro and key extraction: 25° cam.

Euro half-adjustable	Sist.	Ref.	Sist.	Ref.
	TE5	T53W 30 10 N	T10	T10PW 30 10 N
	T60	T65W 30 10 N	T12	T12PW 30 10 N
	T80	T85W 30 10 N	TX80	TX8W 30 10 N
	TK6	AK6W 30 10 N	TK100	TK153010N

* The references do not include the cylinder (order separately)

Accessories and cylinder parts

Disconnecter with micro + interlocking

This case model allows for two different applications by merely switching the cam's position:

1. Cam 90° to the left: Energy-saving device for hotels with cylinder (usually with lighting)

The model with 1 Micro and lighting (1L) and a 687 mortise case is particularly suitable to be used as an energy-disconnecting device in hotel rooms; air conditioning, lights, heating, etc.

The room's masterkeyed key is inserted in the case and, once it rotates, all electric switches can be connected.

When a guest leaves the room and removes the key from the case, all devices remain disconnected.

This system reduces the use of electricity by limiting the use of energy exclusively to the hours spent by the guest in the room.

These cases may be mounted on all of TESA's existing devices.

2. Cam to 25°: Connecting / disconnecting device with key extraction

This model allows the user to connect the microswitch and remove the key leaving the micro connected.

To do this you must rotate the key 180° to the right and return to the original position by removing the key.

At this moment, the micro remains permanently closed.

In order to disconnect the micro, you must rotate the key 180° to the left and return the key to the original position by removing it.

The micro will remain permanently open.

Applications

Those elements that work by day (open micro) but remain permanently disconnected (closed micro) by night.

TESA maintenance spray

A product specially developed to maintain the correct working of the cylinder lock.

Product description:

- » It cleans and lubricates the cylinder.
- » It protects the cylinder from the corrosion and rust.
- » Appropriate between -40° and 600°C
- » Content of each can: 50ml

Product code	Description
SPRAYTESA	12 spray cans per unit box



Shield protective

Product code	Description
ESCUUNIVEURO1	(universal shield protective)



Minimum order quantity 25 units



ASSA ABLOY

Talleres de Escoriaza, S.A.U.
Barrio Ventas, 35 • E-20305 Irun • SPAIN
Tel.: +34 943 669 100 • Fax: +34 943 633 221
www.tesa.es

ASSA ABLOY is the global leader in door opening solutions,
dedicated to satisfying end-user needs for security, safety and convenience